

# easYgen-400

## Manual | Genset Control



easYgen-400

37884A

This is no translation but the original Technical Manual in English.  
Designed in Germany and Poland; manufactured in China.

**Woodward GmbH**

Handwerkstrasse 29

70565 Stuttgart

Germany

Telephone: +49 (0) 711 789 54-510

Fax: +49 (0) 711 789 54-101

E-mail: [stgt-info@woodward.com](mailto:stgt-info@woodward.com)

Internet: <http://www.woodward.com>

## Brief Overview



Fig. 1: easYgen-400

- |                                                                                                                                                                                                                           |                                                                                                                                                                                              |
|---------------------------------------------------------------------------------------------------------------------------------------------------------------------------------------------------------------------------|----------------------------------------------------------------------------------------------------------------------------------------------------------------------------------------------|
| <p>1 Terminals 21 to 24: Digital inputs 01 to 03, COMMON</p> <p>2 Terminals 25 to 28: Generator voltage</p> <p>3 Terminals 33 to 36: Generator current</p> <p>4 USB type B service port for PC/laptop with ToolKit-SC</p> | <p>5 Terminals 1 to 14: Power Supply, Fuel/Gas, Starter, D+, Relay 01 to 04, AI 01 to 04</p> <p>6 Terminals 15 to 17: Magnetic Pickup</p> <p>7 Terminals 18 to 20: CAN (J1939) interface</p> |
|---------------------------------------------------------------------------------------------------------------------------------------------------------------------------------------------------------------------------|----------------------------------------------------------------------------------------------------------------------------------------------------------------------------------------------|

The easYgen-400 is a control unit for engine-generator management applications.

The control unit can be used in simple Start/Stop applications.

### Scope of delivery

The following parts are included in the covering box. Please check prior to installation that all parts are present:

- Device easYgen genset control  
All terminal connectors that need to be screwed are delivered with plug **and** jack
- Clamp fastener installation material (4x)
- "Installation Procedure Supplement" paper with links to the latest edition of Technical Documentation and software for download:  
(<http://www.wwdmanuals.com/easYgen-400>)



Configuration software and Technical Manual are available at Woodward website:  
<http://www.woodward.com/easYgen-400.aspx>

## Sample application setup

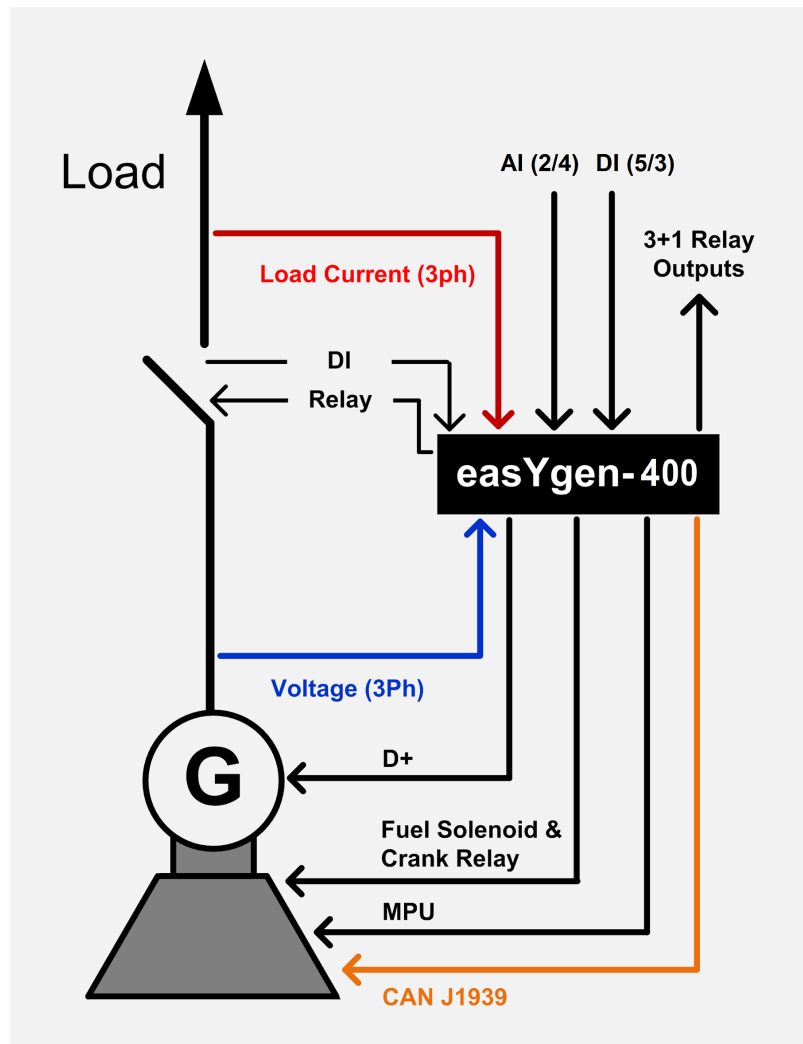

Fig. 2: Sample application setup

A typical application mode for the control unit is the use for non parallel operation in a single genset application.

- In this case, the easYgen will function as an engine control with generator and engine protection.
- The control unit can open and close the circuit breaker .



Transition procedures are described in chapter  
 ↗ Chapter 5.5 "Transition Procedures"  
 on page 64.

# Table of contents

<b>1</b>	<b>General Information</b> .....	<b>9</b>
1.1	About this Manual.....	9
1.1.1	Revision History.....	9
1.1.2	Symbols Used in this manual.....	9
1.2	General Information.....	10
1.2.1	Copyright And Disclaimer.....	10
1.2.2	Service And Warranty.....	11
1.2.3	Safety.....	11
1.2.3.1	Intended Use.....	11
1.2.3.2	Personnel.....	12
1.2.3.3	General hazard warnings.....	13
<b>2</b>	<b>System Overview</b> .....	<b>15</b>
2.1	Display and Status Indicators.....	15
2.2	Operation Modes.....	16
2.2.1	Operation Mode AUTO.....	16
2.2.2	Operation Mode MANual.....	17
2.2.3	Operation Mode STOP.....	17
2.3	Features and Functions of both easYgen-400 and -1400.....	17
2.4	Functions.....	19
2.5	Intended Use of This Control.....	19
<b>3</b>	<b>Installation</b> .....	<b>21</b>
3.1	Mounting.....	21
3.2	Wiring.....	21
3.3	Interfaces.....	26
3.4	Install ToolKit-SC.....	26
<b>4</b>	<b>Configuration</b> .....	<b>27</b>
4.1	Access to the Control.....	28
4.1.1	Access via the Front Panel.....	28
4.1.1.1	Front Panel: Operating and Display Elements.....	28
4.1.1.2	Front Panel Control.....	29
4.1.2	Configure ToolKit-SC.....	32
4.1.2.1	Configure Communication.....	32
4.1.2.2	Manage Configuration Data.....	32
4.1.2.3	Select Language.....	33
4.1.3	Access via ToolKit-SC Configuration Tool.....	33
4.2	Parameters.....	34
4.2.1	Parameter Menu Structure.....	34

## Table of contents

4.2.2	Parameter Settings Menu--HMI Access.....	35
4.2.3	Configure Measurement.....	36
4.2.4	Configure Application.....	37
4.2.4.1	Configure Inputs and Outputs.....	37
4.2.4.2	Configure Engine.....	42
4.2.4.3	Configure TEST Run.....	43
4.2.4.4	Configure Breakers.....	44
4.2.5	Configure Monitoring.....	44
4.2.5.1	Monitoring Generator .....	44
4.2.5.2	Monitoring Breakers.....	45
4.2.5.3	Monitoring Engine.....	46
4.2.5.4	Other Monitoring.....	46
4.2.6	Configure Maintenance.....	47
4.2.7	Configure Counters.....	47
4.2.8	Configure Language / Clock.....	48
4.2.9	Configure System Management.....	48
4.2.10	Configure HMI.....	49
4.3	Selectable Inputs/Outputs/Sensors.....	50
4.3.1	Programmable Sensors.....	50
4.3.2	Programmable Inputs.....	51
4.3.3	Programmable Outputs.....	52
4.4	Status Menu.....	53
4.4.1	HMI Status Screens.....	53
4.4.2	ToolKit-SC Status Screens.....	54
<b>5</b>	<b>Operation.....</b>	<b>57</b>
5.1	Front Panel: Operating and Display Elements.....	57
5.2	Warning/Alarm Signaling.....	58
5.2.1	Alarm Acknowledgment.....	59
5.3	Operation Modes.....	59
5.3.1	Operation Mode AUTO.....	59
5.3.2	Operation Mode MANual.....	60
5.3.3	Operation Mode STOP.....	60
5.4	START/STOP Operation.....	60
5.4.1	Start engine to supply load.....	60
5.4.2	Stop engine.....	61
5.4.3	MANual START/STOP.....	64
5.5	Transition Procedures.....	64
5.5.1	Disconnect during cranking.....	64
5.6	Trouble Shooting.....	65
<b>6</b>	<b>Application.....</b>	<b>67</b>

---

6.1	Commissioning.....	67
<b>7</b>	<b>Interfaces and Protocols.....</b>	<b>69</b>
7.1	J1939.....	69
<b>8</b>	<b>Technical Specifications.....</b>	<b>75</b>
8.1	Measuring and Monitoring.....	77
<b>9</b>	<b>Appendix.....</b>	<b>79</b>
9.1	Alarms and Warnings.....	79
9.1.1	Alarm Classes.....	79
9.1.2	Warnings.....	79
9.1.3	Shutdown Alarms.....	80
9.2	Trouble Shooting.....	81
<b>10</b>	<b>Glossary And List Of Abbreviations.....</b>	<b>83</b>
<b>11</b>	<b>Index.....</b>	<b>85</b>

Table of contents

---



# 1 General Information

## 1.1 About this Manual

### 1.1.1 Revision History

Rev.	Date	Editor	Changes
NEW	2018-11	PC	<p>Describes device implemented software version 1.x and ToolKit-SC version 1.4.x.x</p> <p><b>Technical Manual</b></p> <ul style="list-style-type: none"> <li>■ Release = 1st issue</li> </ul>

### 1.1.2 Symbols Used in this manual

#### Safety instructions

Safety instructions are marked with symbols. The safety instructions are always introduced by signal words that express the severity of the danger.



#### **DANGER!**

This combination of symbol and signal word indicates an immediately dangerous situation that could cause death or severe injuries if not avoided.



#### **WARNING!**

This combination of symbol and signal word indicates a possibly dangerous situation that could cause death or severe injuries if it is not avoided.



#### **CAUTION!**

This combination of symbol and signal word indicates a possibly dangerous situation that could cause slight injuries if it is not avoided.



#### **NOTICE!**

This combination of symbol and signal word indicates a possibly dangerous situation that could cause property and environmental damage if it is not avoided.

#### Tips and recommendations









*This symbol indicates useful tips and recommendations as well as information on efficient and trouble-free operation.*

#### Additional markings

To highlight instructions, results, lists, references, and other elements, the following markings are used in these instructions:

## General Information

General Information > Copyright And Disclaimer

Marking	Explanation
	Step-by-step instructions
	Results of action steps
	References to sections of these instructions and to other relevant documents
	Listing without fixed sequence
[Buttons]	Operating elements (e.g. buttons, switches), display elements (e.g. signal lamps)
"Display"	Screen elements (e.g. buttons, programming of function keys)
"Screen xx → Screen xy → Screen xz" ...	Menu path. The following information and setting refer to a page on the HMI screen or ToolKit located as described here.
 	Some parameters/settings/screens are available only either in ToolKit or on the HMI/display.



### **Dimensions in Figures**

*All dimensions with no units specified are in mm.*

## 1.2 General Information

### 1.2.1 Copyright And Disclaimer

#### Disclaimer

All information and instructions in this manual have been provided under due consideration of applicable guidelines and regulations, the current and known state of the art, as well as our many years of in-house experience. Woodward assumes no liability for any damage due to:

- Failure to comply with the instructions in this manual
- Improper use / misuse
- Willful operation by non-authorized persons
- Unauthorized conversions or non-approved technical modifications
- Use of non-approved spare parts

The originator is solely liable for the full extent for damages caused by such conduct. The obligations agreed upon in the delivery contract, the general terms and conditions, the manufacturer's delivery conditions, and the statutory regulations valid at the time the contract was concluded, apply.

#### Copyright

This manual is protected by copyright. No part of this manual may be reproduced in any form or incorporated into any information retrieval system without written permission of Woodward GmbH.

Delivery of this manual to third parties, duplication in any form - including excerpts - as well as exploitation and/or communication of the content, are not permitted without a written declaration of release by Woodward GmbH.

Actions to the contrary will entitle us to claim compensation for damages. We expressly reserve the right to raise any further accessory claims.

## 1.2.2 Service And Warranty

Opening the device will nullify any warranty!



### CAUTION!

Any unauthorized modifications or use of this equipment outside its specified mechanical, electrical, or other operating limits may cause personal injury and/or property damage, including damage to the equipment.

Any such unauthorized modifications

- constitute "misuse" and/or "negligence" as per the product warranty
- thereby exclude warranty coverage for any resulting damage, and
- invalidate product certifications or listings.

Our Customer Service is available for technical information. Please see page 2 for contact details.

In addition, our employees are interested in any new information and experiences that arise from usage and could be valuable for improving our products.

### Warranty terms



*Please enquire about the terms of warranty from your nearest Woodward representative.*

*To find your closest Customer Service representative, go to:  
<http://www.woodward.com/Directory.aspx>*

## 1.2.3 Safety

### 1.2.3.1 Intended Use

The easYgen unit has been designed and constructed solely for the intended use described in this manual.

- Intended use requires operation of the control unit within the range outlined in the specifications listed in ↪ *Chapter 8 "Technical Specifications" on page 75.*
- All permissible applications are outlined in ↪ *Chapter 6 "Application" on page 67.*
- Intended use includes compliance with all instructions and safety notes presented in this manual.

## General Information

General Information > Safety > Personnel

- Any use which exceeds or differs from the intended use shall be considered improper use.
- No claims for any kind of damage will be considered if such claims result from improper use.



### NOTICE!

#### Damage due to improper use!

Improper use of the remote panel unit may cause damage to the control unit as well as to the connected components.

Improper use includes, but is not limited to:

- Operation outside the specified operating conditions.

### 1.2.3.2 Personnel



### WARNING!

#### Hazards due to insufficiently qualified personnel!

If unqualified personnel perform work on or with the control unit hazards may arise which can cause serious injury and substantial damage to property.

- Therefore, all work must only be carried out by appropriately qualified personnel.

This manual specifies the personnel qualifications required for the different areas of work, listed below:

- Well trained for electrical installations.
- Aware of the local safety regulations.
- Experienced in working with electronic measuring and control devices.
- Allowed to manage the controlled (engine/generator) system.

The workforce must only consist of persons who can be expected to carry out their work reliably. Persons with impaired reactions due to, for example, the consumption of drugs, alcohol, or medication are prohibited.

When selecting personnel, the age-related and occupation-related regulations governing the operating location must be observed.

### 1.2.3.3 General hazard warnings

#### Hazards by system controlled

**DANGER!****Moving parts and dangerous electricity!**

Be aware that the remote control of a system that is managing life-threatening engine-generator-electricity parts must be adapted to the local situation!

The following safety notes cover both the device itself and basics of the overall genset system. The dedicated genset-system safety instruction must be considered, too!

#### Prime mover safety

**WARNING!****Hazards due to insufficient prime mover protection**

The engine, turbine, or any other type of prime mover must be equipped with an overspeed (over-temperature, or over-pressure, where applicable) shutdown device(s) that operates independently of the prime mover control device(s) to protect from runaway or damage to the engine, turbine, or any other type of prime mover. Failure to comply with this also poses the risk of personal injury or loss of life if the mechanical-hydraulic governor(s) or electric control(s), the actuator(s), fuel control(s), the driving mechanism(s), the linkage(s), or the controlled device(s) fail.

## General Information

---

General Information > Safety > General hazard warnings

## 2 System Overview

### General notes

The easYgen is a stand-alone genset controller with measuring, monitoring, and breaker control functionality. It comes with an easily mountable plastic housing covering a thoroughly tested electronic-electrical system.

Display and buttons of the HMI offer access to states and values, as well as access to the application. Password protection enables the assignment of multiple operation access levels. Remote access, monitoring, visualization, and configuration are possible via integrated interfaces. Communication between easYgens using PLC control or as a network member offers an enhanced system management range; additionally supported by easy to implement accessories.



*For even higher challenges in genset control, the easYgen series offers further solutions encompassing complex and ambitious applications.*

*For dedicated protection tasks, ask Woodward for its protection (relay) solutions.*

### 2.1 Display and Status Indicators

#### General Notes

HMI and the configuration software enable access to control, settings, and visualization. The front panel offers a number of functionally defined buttons and a set of menu management buttons. LEDs visualize fixed states, the graphic display works together with the menu management buttons to show all necessary information.



#### **Restrictions**

*Full access to all parameters and settings with configuration software only!*

*HMI access offers a number of information screens in general, and enables - password-protected - access to parameters and settings.*



Fig. 3: easYgen-400

## 2.2 Operation Modes

### General notes

The easYgen offers three operation modes:

- AUTO
- MANUAL (MAN)
- STOP
- ... and an internal (non) operating phase during the start of the device itself

The operation mode can be initiated – provided the current settings allow for this funktion:

- directly by pressing the respective button on the front panel
- directly by click on the respective button on the ToolKit-SC remote screen
- via discrete inputs
- via interface

### 2.2.1 Operation Mode AUTO

#### General notes

In operation mode AUTO, both genset and breaker are under easYgen control. The start and stopping of the engine is managed automatically, along with opening/closing the breaker.

Depending on the settings and the application status, AUTO control can:

- supply load by generator
- start the engine
- stop the engine



## 2.2.2 Operation Mode MANual

### General notes

In operation mode MANual, both genset and breakers are independent of each other under easYgen control.

The starting and stopping of the engine are managed using the same procedure as in AUTO mode but without breaker control. Breakers can be opened and closed without taking care of load or genset state!

## 2.2.3 Operation Mode STOP

### General notes

In operation mode STOP, the breaker is open and the engine is not running.



*This is a configurable operation mode, only. This is NO emergency STOP!*

## 2.3 Features and Functions of both easYgen-400 and -1400

Both, easYgen-400 and easYgen-1400, are very similar in hardware and software. The easYgen-1400 is the device with the higher functionality. For purposes of comparison and better differentiation, both are described below.

**easYgen-400** is intended to be used for single automation systems, auto start/stop of the unit is performed using a remote signal.

**easYgen-1400** has all the functions of the easYgen-400 as well as automatic mains failure function (AMF), which is particularly well-suited for single automation systems that include mains and generator.

### Functional Blocks

Item		easYgen-400	easYgen-1400
LCD (with backlight)	Dimension	4.3"	4.3"
	Pixel	480 x 272	480 x 272
AMF		no	•
Digital input ports		5	5
Output ports		6	6
Sensors		3	3
Schedule function		•	•
J1939		•	•
USB (Type B)		•	•
Real-time clock		•	•
Event log		•	•

### Key characteristics

- With ARM-based 32-bit SCM, highly integrated hardware, high reliability level.
- Multilingual interface (English, Chinese, Spanish, Russian, Portuguese, Turkish, Polish, and French) making commissioning convenient for factory personnel.

- Improved LCD with high wear-resistance and scratch resistance due to hard screen acrylic.
- Silicon panel and pushbuttons for better operation in high-temperature environments.
- Equipped with CAN bus port for communicating with the J1939 genset. Monitoring frequently-used data on ECU machine, such as water temperature, oil pressure, speed, fuel consumption, ECU machine, and additionally also control start, stop, raising speed, and speed droop via CAN bus port.
- Suitable for 3-phase 4-wire, 3-phase 3-wire, single phase 2-wire, and 2-phase 3-wire systems with voltage 120/240 V and frequency 50/60 Hz.
- **easYgen-1400 only:** Collects and shows 3-phase voltage, current, power parameter, and frequency of generator and additionally 3-phase mains voltage. Mains Generator Line voltage ( $U_{AB}$ ,  $U_{BC}$ , and  $U_{CA}$ ) Line voltage ( $U_{AB}$ ,  $U_{BC}$ , and  $U_{CA}$ ) Phase voltage ( $U_A$ ,  $U_B$ , and  $U_C$ ) Phase voltage ( $U_A$ ,  $U_B$ , and  $U_C$ )
- **easYgen-400 only:** Collects and shows 3-phase voltage, current, power parameter and frequency of generator. Generator Line voltage ( $U_{AB}$ ,  $U_{BC}$ , and  $U_{CA}$ ) Line voltage ( $U_{AB}$ ,  $U_{BC}$ , and  $U_{CA}$ ) Phase voltage ( $U_A$ ,  $U_B$ , and  $U_C$ ) Phase voltage ( $U_A$ ,  $U_B$ , and  $U_C$ )
- Phase sequence, frequency, Load current  $I_A$ ,  $I_B$ ,  $I_C$
- Each phase: Total active power [kW], Total reactive power [kvar], Total apparent power [kVA], Average power factor PF
- Accumulated Total generator power [kWh], [kvarh], [kVAh]
- **easYgen-1400 only:** For Mains, controller can detect over and under voltage, over and under frequency, loss of phase and incorrect phase sequence.
- For generator, controller can detect overvoltage and undervoltage, overfrequency and underfrequency, loss of phase, incorrect phase sequence, overpower and reverse power, overcurrent.
- 2 fixed analog sensors: Engine temperature and oil pressure.
- Precision measure and display parameters about engine, temp. (WT) °C/°F can both be displayed oil pressure (OP) kPa/psi/bar Speed (SPD) r/min (unit) battery voltage (VB) V (unit) charger voltage (VD) V (unit) hour count (HC) can accumulate max. 65535 hours. Start times can accumulate max. 65535 times.
- Protection: automatic start/stop of the genset.
- **easYgen-1400 only:** ATS (Auto Transfer Switch) control with failure indication and protection function.
- All output ports are relay-out.
- Parameter settings: Parameters can be modified and stored in internal FLASH memory and cannot be lost even in case of a power outage; most can be adjusted on the front panel of the controller and all can be modified using ToolKit-SC configuration software on the computer via USB port.
- Various temperature and oil pressure curves are available. More sensor curves can be defined as per user requirements.
- Multiple crank disconnect options (generator frequency, speed sensor, oil pressure) are available.
- Wide power supply range DC (8 to 35) V, suitable for different start battery voltage environment.
- Event log, real-time clock, scheduled start & stop generator (can be set as start genset once a day/week/month with or without load).
- Logon wallpaper and display time are user-defined.

- Can be used on pumping units and as an indicating instrument (indicate and alarm are "enable" only, relay is inhibited).
- Maintenance function. Actions such as warning or shutdown can be set when the maintenance timer reaches its specified time.
- All parameters are digitally adjusted (instead of conventional analog modulation with normal potentiometer) for more reliability and stability.
- International Protection Rating IP55 due to rubber seal installed between the controller enclosure and front panel.
- Metal fixing clips enable high stability in high temperature environment.
- Modular design, self-extinguishing ABS plastic enclosure, plug-gable connection terminals and embedded installation way; compact structure with easy mounting.
- Total run time and total electric energy can be reset for convenience.
- Customizable start-up screen (text/image).
- Customizable HMI status screens (content) via drag-and-drop.

## 2.4 Functions

- Protection: automatic start/stop of the genset, ATS (Auto Transfer Switch) control with failure indication and protection function
- All output ports are relay-out
- Parameter settings: parameters can be modified and stored in internal FLASH memory and cannot be lost even in case of a power outage; most of them can be adjusted using front panel of the controller and all of them can be modified using ToolKit-SC on a PC via USB port.
- Temperature and oil pressure curves can be used directly and users can define the sensor curves by themselves.
- Multiple crank disconnect conditions (generator frequency, speed sensor, oil pressure) are optional.
- Event log, real-time clock, scheduled start & stop generator (can be set as start genset once a day/week/month with or without load).
- Start-up logo and display time are user-defined.
- Can be used on pumping units and as an indicating instrument (indicate and alarm are enable only, relay is inhibited).
- Maintenance function: Actions (warning or shutdown) can be set when maintenance time out.
- Instead of conventional analog modulation with a potentiometer, all parameters use digital adjustment for more reliability and stability.
- Accumulative total run time and total electric energy of A and B. The user can reset it to 0 and re-accumulate the value, which allows to count the total value.

## 2.5 Intended Use of This Control

easYgen-400 genset controllers are used for genset automation and monitor control system of single unit, offering:

- automatic start/stop,
- data measurement,

## System Overview

---

### Intended Use of This Control

- alarm protection and
- three remote features: control, measuring and communication.

The easYgen genset controllers use 32 bits micro-processor technology with features such as precision parameters measuring, fixed value adjustment, time setting or threshold adjusting. Most of these parameters can be set on the front panel and all parameters can be set using a computer (via USB port). The controllers can be used for a number of automatic genset control systems. They have a compact structure, easy connections and are highly reliable.

## 3 Installation

### 3.1 Mounting

Fix the controller unit using the included clips. Please see below for the overall dimensions of the controller and the cutout dimensions of the panel.



*Tighten the clips so that they are tight - but not too tight - in order to achieve the best IP protection result!*

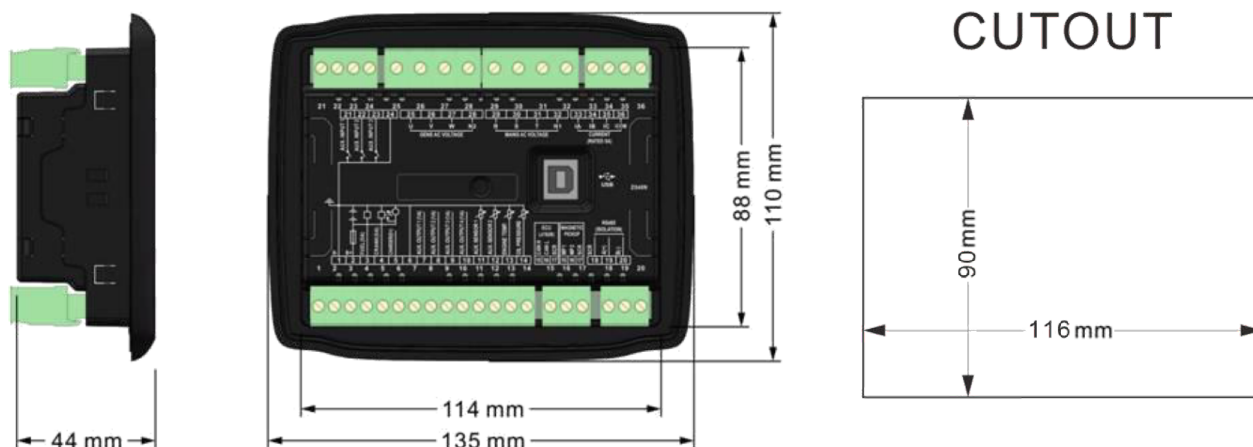

Fig. 4: easYgen-400/1400 cut-out

### 3.2 Wiring

#### General Notes



#### **Battery Voltage Input**

*This controller can be used with batteries with a voltage range from 8 to 35 V<sub>DC</sub>.*

*The negative pole of the battery must be connected to the engine shell. The wire between the power supply and the battery must have a cross section above 2.5 mm<sup>2</sup>.*

*If floating charge is configured: To prevent the controller from disturbing charges, do the following:*

- *Directly connect the output wires of the charger to the positive and negative poles of the battery.*
- *Connect the wires from the positive and negative pole of the battery to the positive and negative input ports of the controller.*

**Speed Sensor Input**

Connect the two signal wires to terminals 15 and 16. The output voltage of speed sensor should be within 1 to 24  $V^{eff}$ . 12  $V^{eff}$  is recommended for rated speed.

**CAUTION!****Digital (Relays) Outputs**

To prevent the controller from damage:

For DC current relays: Attach freewheel diodes at both ends of relay's coils.

For AC current relays: Increase resistance of the return circuit of the relays coils.

**WARNING!**

If there is a load current, opening the circuit of the output side of the transformer is not allowed!

**CAUTION!****Withstand Voltage Test**

Disconnect all terminal connections before performing a high-voltage test of the installed controller.

## Terminals

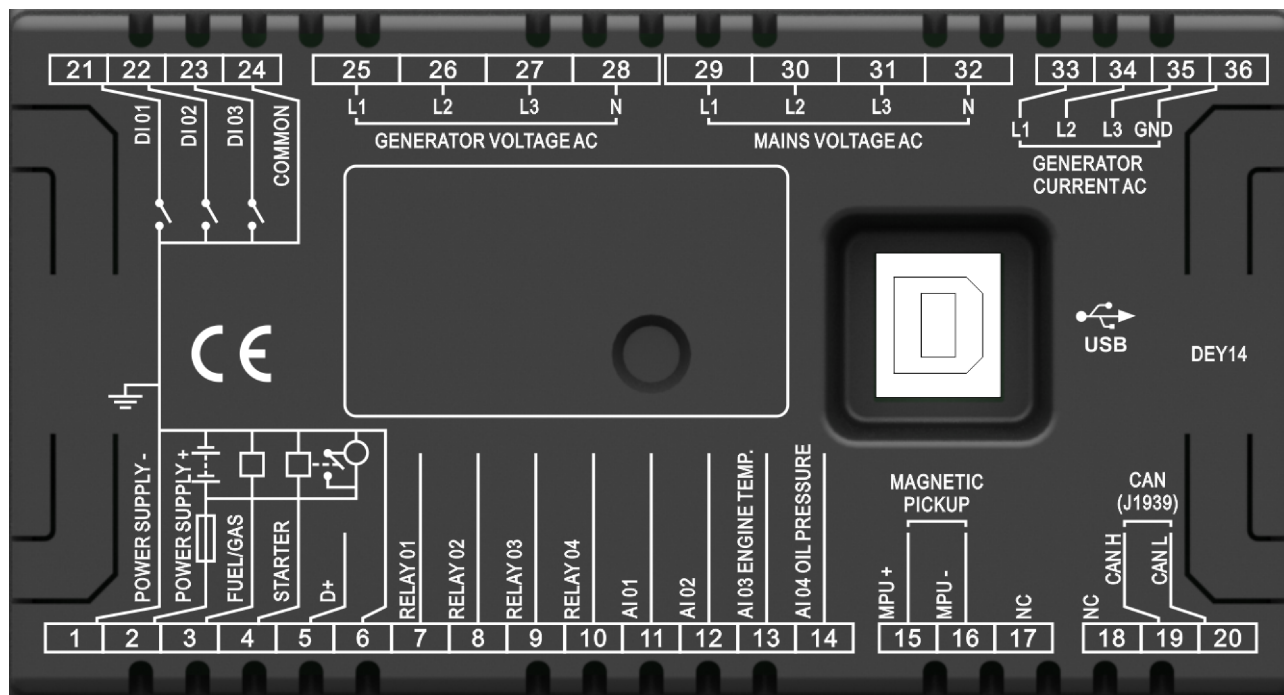

Fig. 5: easYgen-400 Terminals

No.	Function	Cable Size	Remarks	
1	POWER SUPPLY -	2.5 mm <sup>2</sup>	Connected to positive pole of starter battery. If the wire is longer than 30 m, use double wires in parallel. Max. 20 A fuse is recommended.	
2	POWER SUPPLY +	2.5 mm <sup>2</sup>	Connected to the negative pole of starter battery	
3	FUEL Relay Output	1.5 mm <sup>2</sup>	B+ is supplied by 2 points, rated 7 A	
4	Start Relay Output	1.5 mm <sup>2</sup>	B+ is supplied by 3 points, rated 16 A	Connected to starter coil
5	Charging Generator D+ Input	1.0 mm <sup>2</sup>	Connect to D+ (WL) terminal.	
6	Common earth ground	1.5 mm <sup>2</sup>	Inside connect to B-.	
7	Aux. Relay Output 1	1.0 mm <sup>2</sup>	Relay common port	Details see <a href="#">Chapter 4.3.3 "Programmable Outputs"</a> on page 52
8	Aux. Relay Output 2	1.0 mm <sup>2</sup>	Normal close output, 7 A rated.	
9	Aux. Relay Output 3	1.0 mm <sup>2</sup>	Relay normal open volt-free contact output, 16 A rated	
10	Aux. Relay Output 4	1.0 mm <sup>2</sup>	Relay normal open volt-free contact output, 16 A rated	
11	Analog Input 01	1.0 mm <sup>2</sup>	Connect to temperature, oil pressure, level resistance sensor OR discrete input 5 (Ground connected is active)	
12	Analog Input 02	1.0 mm <sup>2</sup>	Connect to temperature, oil pressure, level resistance sensor OR discrete input 5 (Ground connected is active)	
13	Analog Input 03 Engine temp	1.0 mm <sup>2</sup>	Connect to water /cylinder temp. resistance type sensor	
14	Analog Input 04 Oil Pressure Sensor Input	1.0 mm <sup>2</sup>	Connect to oil pressure resistance type sensor. Connect to oil pressure resistance.	Details see <a href="#">Chapter 4.3.2 "Programmable Inputs"</a> on page 51
15	Speed sensor input	0.5 mm <sup>2</sup>	Connected to Speed sensor, shielding line is recommended	
16	Speed sensor input, B- is normal open output, 7A rated.	0.5 mm <sup>2</sup>	Connected to Speed sensor, shielding line is recommended	

## Installation

## Wiring

No.	Function	Cable Size	Remarks
17	NC		Empty terminal
18	NC		Empty terminal
19	CAN H	0.5 mm <sup>2</sup>	Impedance-120Ω shielding wire is recommended, its single-end connect with ground (the controller without CANBUS function does not have this terminal).
20	CAN L	0.5 mm <sup>2</sup>	Impedance-120Ω shielding wire is recommended, its single-end connect with ground (the controller without CANBUS function doesn't have this terminal).
21	Configurable Input 1	1.0 mm <sup>2</sup>	Ground connected is active (B-)
22	Configurable Input 2	1.0 mm <sup>2</sup>	Ground connected is active (B-)
23	Configurable Input 4	1.0 mm <sup>2</sup>	Ground connected is active (B-)
24	Sensor common	1.0 mm <sup>2</sup>	Sensor common port
25	Generator U phase Voltage Sensing Input	1.0 mm <sup>2</sup>	Connect to U phase output(2A fuse is recommended)
26	Generator V phase Voltage Sensing Input	1.0 mm <sup>2</sup>	Connect to V phase output(2A fuse is recommended)
27	Generator W phase Voltage Sensing Input	1.0 mm <sup>2</sup>	Connect to W phase output(2A fuse is recommended)
28	Generator N2 Input	1.0 mm <sup>2</sup>	Connect to generator N-wire
29	NC		Empty terminal
30	NC		Empty terminal
31	NC		Empty terminal
32	NC		Empty terminal
33	CT A Phase Sensing Input	1.5 mm <sup>2</sup>	Connect secondary coil, rated 5A
34	CT B Phase Sensing Input	1.5 mm <sup>2</sup>	
35	CT C Phase Sensing Input	1.5 mm <sup>2</sup>	
36	CT Common port	1.5 mm <sup>2</sup>	Refer to Installation description

Details see [Chapter 4.3.2](#)  
"Programmable Inputs"  
on page 51



## Wiring typical applications

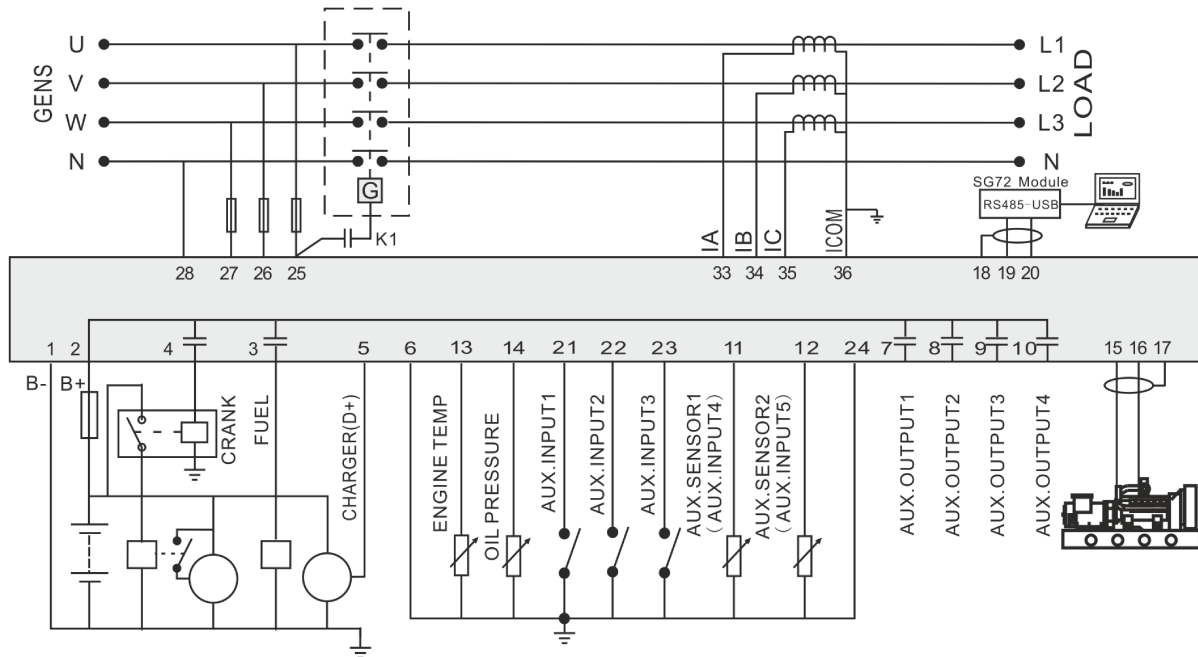

Fig. 6: easYgen-400 wiring of a typical application

## Installation

Install ToolKit-SC

### 3.3 Interfaces

#### Interface Connections

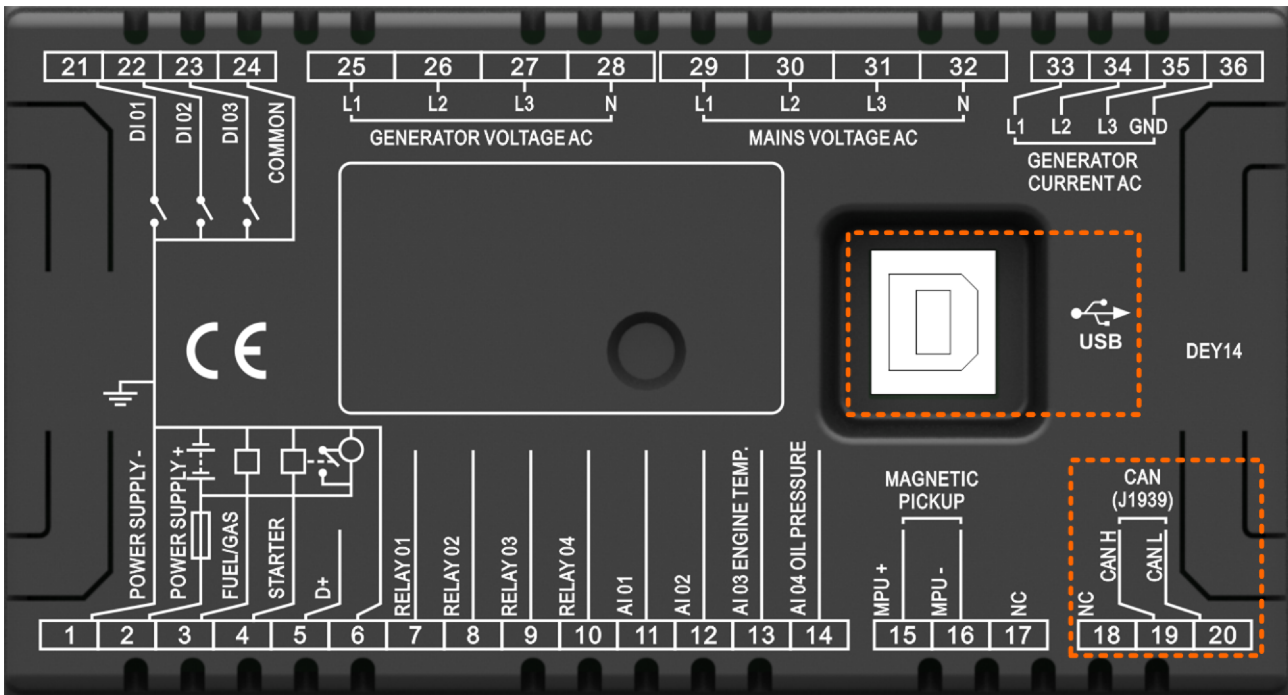

Fig. 7: Interface Connections

Interfaces	Intended use	Remarks
J1939	Engine communication J1939 and others	For details, see <a href="#">Chapter 8</a> "Technical Specifications" on page 75
USB	Configuration tool "ToolKit-SC" access only!	

### 3.4 Install ToolKit-SC

#### General notes

ToolKit-SC is a software tool for configuration including configuration file management, monitoring, remote control, and custom language management. The ToolKit-SC.exe file is available as a download on the Woodward website and the device-specific download website.

Please follow installation instruction.



**Remove old software version(s) before update!**

Make sure your custom configuration and language pack(s) are saved in a separate directory!

Prior to the installation of the new ToolKit-SC software, all older versions of the ToolKit-SC software must be un-installed.

## 4 Configuration



### CAUTION!

Only change controller parameters in standby mode! Otherwise, abnormal conditions including shutdown may occur.

Configuration can be performed via

- HMI using front panel buttons
- USB connected PC/laptop using ToolKit-SC configuration software (full edit)

The configuration software ToolKit-SC is part of the delivery and (latest edition) can be downloaded from our website [Woodward.com](http://Woodward.com). Search for "ToolKit-SC".



*Different digital/relay outputs can be configured with the same output type .*

*E.g.: Contents Setting of Flexible Output Port 1 is Output Type #18 "Horn". So #18 "Horn" can still be used for other Output ports, too.*



*Input the sensor curve: X values (resistor) must be arranged increasing from small to large, otherwise, an error occurs.*

*If selected sensor type is "None", the sensor curve is not working.*

*If a sensor has an alarm switch only, the release condition of this sensor must be configured as "Never", otherwise, a warning displays or a shutdown can occur.*

## Configuration

Access to the Control > Access via the Front Panel > Front Panel: Operating and...

### 4.1 Access to the Control

#### 4.1.1 Access via the Front Panel

##### 4.1.1.1 Front Panel: Operating and Display Elements

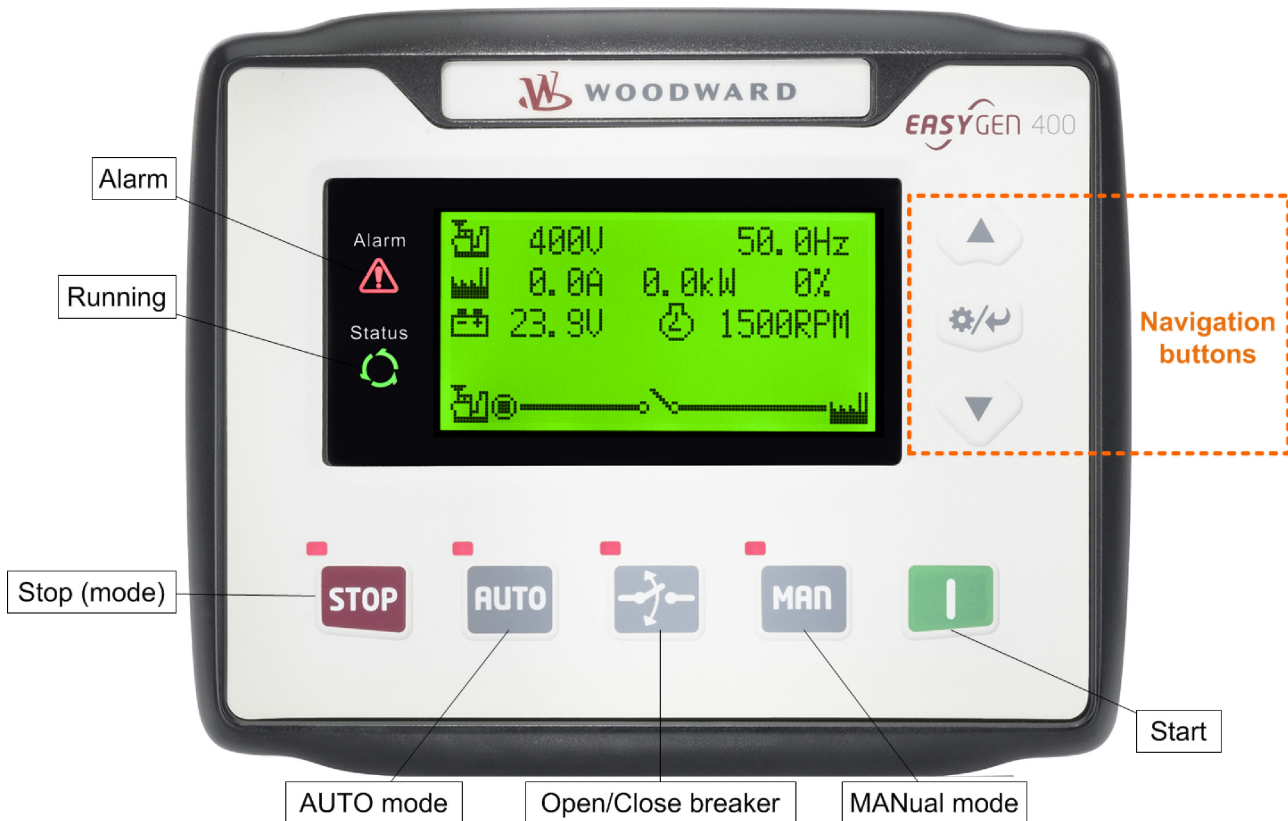











Fig. 8: easYgen-400

Icons	Keys	Description
	STOP	Auto/Manual mode: Stops running generator Stop mode: Resets alarm Lamp test (press at least 3 seconds) <b>Notes</b> During stopping process, press this button again to stop generator immediately.
	I (START)	MANual mode: Start genset
	MAN (Manual Mode)	Press this key and the controller enters into MAN mode
	AUTO (Automatic Mode)	Press this key and the controller enters into AUTO mode
	Open/Close breaker	Release breaker control in MAN mode. The navigation button "Up/Increase" is used to close the GCB. The navigation button "Down/Decrease" is used to open the GCB

Icons	Keys	Description
	Up/Increase	1) Screen scroll 2) Settings menu: Up cursor and increase value in Close GCB in MAN mode
	Down/Decrease	1) Screen scroll 2) Settings menu: Down cursor and decrease value 3) Open GCB in MAN mode 4) Lamp test: Press button for 5 sec
	Right Set/Confirm	1) Mute horn 2) Settings menu: Hold button for 5 sec 3) Settings menu: select digit position
	Alarm	
	Status	



*In MANUAL mode:*

*Pressing **MAN** and **I** (START) simultaneously will force the generator to crank. Successful start will not be judged according to crank disconnect conditions, the operator needs to crank the starter motor manually; Once the engine has fired, the operator must release the button. Only then the start output will be deactivated, safety on delay will start.*



#### **WARNING!**

Users can change passwords. Please make note of the new password after changing it. If you forget the password, please contact Woodward services and send all device information on the "ABOUT" page of the controller for legitimation.

### 4.1.1.2 Front Panel Control

#### General Notes



*Buttons below the screen/display have specific functions that are described in chapter  Chapter 5 "Operation" on page 57.*

The configuration via front panel is limited to the current code level and restricted due to the editing/input possibilities of different buttons. Full access to all configuration options is only available when using the configuration (software) tool.

Navigation buttons allow for selection of a dedicated menu screen and the increase/decrease, next/previous, and enter commands.

## Configuration

Access to the Control > Access via the Front Panel > Front Panel Control

### On main menu (top) level:

1. Use next or previous button to switch to next or previous screen
2. Jump to main screen with "Right; Set/Confirm" button
3. Press and hold the ENTER button for more than three seconds.
  - ⇒ The main menu opens.

### In main menu buttons work like typical button managed inputs do:

1. Use down/decrease and up/increase button to select item/screen.
2. Enter using the ↵ button.
3. Use down/decrease and up/increase button to select item
4. To select several items: Use next (or previous) button(s) to select item.
5. ... Enter with ↵ and repeat steps 4. and 5. as often as required.
6. Make sure that your latest input was entered.
7. Go back to the upper level using the "Right; Set/Confirm" button
8. Repeat step 7. as often as required until you reach the main menu screen.

#### 4.1.1.2.1 HMI Screens Without Password Level

##### General Notes

The main screen displays an overview over values, modes, messages and states. Two additional LEDs to the left of the display flash to indicate an alarm or the running of the system.

The up and down buttons let you scroll to the other screens in a loop:

- Home screen
- Status
- Engine
- Generator
- Load
- Alarm
- Home screen etc.

The first screen includes:

- Gen: voltage, frequency, current, active power, reactive power
- Engine: speed, temperature, oil pressure, battery voltage
- Other states

2nd screen includes:

- Status\* of genset and breakers



*\*) This easYgen control model has no mains states and so no mains status screen*

3rd screen includes:

- Speed, engine temperature, engine oil pressure, fuel level, auxiliary analog 1, auxiliary analog 2, battery voltage, charger voltage, accumulated run time, accumulated start times, user's total run time A, user's total run time B.
- **If connected with an J1939 engine via CANBUS port only:** coolant pressure, coolant level, fuel temperature, fuel pressure, inlet temperature, exhaust temperature, turbo pressure, fuel consumption, total fuel consumption and so on.  
(Different engine with different parameters)

4th screen includes:

- Phase voltage, line voltage, frequency, phase sequence

5th screen includes:

- Current, active power (positive and negative), total active power (positive and negative), reactive power (positive and negative), total reactive power (positive and negative), apparent power, total apparent power,
- power factor (positive and negative), average power factor (positive and negative),
- accumulated energy,
- earth current,
- total electric energy A and B.

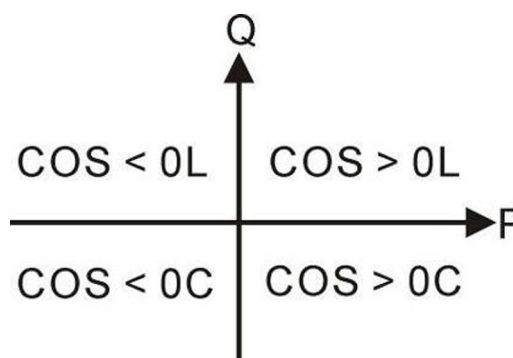

Fig. 9: Power Factor

P Active power

Q Reactive power

Power factor	Conditions	Active power	Reactive power	Remark
COS>0L	P>0, Q>0	Positive	Positive	Positive inductive load
COS>0C	P>0, Q<0	Positive	Negative	Positive capacitive load
COS<0L	P<0, Q>0	Negative	Positive	Negative inductive load
COS<0C	P<0, Q<0	Negative	Negative	Negative capacitive load



\*) This easYgen control model has no mains states and so no mains status screen

## Configuration

Access to the Control > Configure ToolKit-SC > Manage Configuration Data

6th screen includes:

- Display all alarm information e.g., warning alarm, shutdown alarm, trip alarm, and trip and stop alarm.



### **ECU alarms and shutdown alarms:**

*If the alarm information is displayed, check the engine, otherwise, please check the manual of the generator for the respective SPN alarm code.*



### **Screens**

*Some screens are only visible in configuration mode. Press "Set/Confirm" button to switch to configuration mode.*

Screens in configuration mode:

- 1 Set parameters
- 2 Information
- 3 Set language
- 4 Event log
- 5 ECU DM2
- 6 Maintenance

## 4.1.2 Configure ToolKit-SC



*After ToolKit-SC has been started, it tries to connect to the last device that has been connected. If the setup has not changed, the values and settings of the device are read and the visualization is updated.*

The lower status bar shows the current status of the connection and if there is a warning.

### 4.1.2.1 Configure Communication

Make sure that the connection hardware and your laptop/PC settings are correct.

"COM:" offers the following connections:

- USB

### 4.1.2.2 Manage Configuration Data

Configuration file handling:

- Save with "File → Save Config Strg+S"
- Select the default configuration (factory settings) with "File → New Config → [device name]"



Access to the Control &gt; Access via ToolKit-SC Conf...

- Load a configuration into ToolKit-SC with “File  
→ Open Config Strg+O”
- Print the current configuration (to your default printer) with “File  
→ Print Config”

**Refresh config!**

A configuration update between ToolKit-SC and the device (and vice versa) requires pushing the button “Read config” or “Write config”!

**4.1.2.3 Select Language****General notes**

ToolKit-SC can display English, Chinese, or Traditional Chinese. These languages can be selected from the “Language” menu.

The easYgen device can use one of eight pre-set languages: English, Chinese, Spanish, Russian, Portuguese, Turkish, Polish, French. The display language is changed once the configuration has been written to the device.



If a menu is open on the device while you change the language in ToolKit, the new language will display after pressing a front panel button.

**4.1.3 Access via ToolKit-SC Configuration Tool****ToolKit-SC Screen Overview**

Fig. 10: ToolKit-SC home screen

## Configuration

Parameters > Parameter Menu Structure

1. Open ToolKit-SC on your computer.

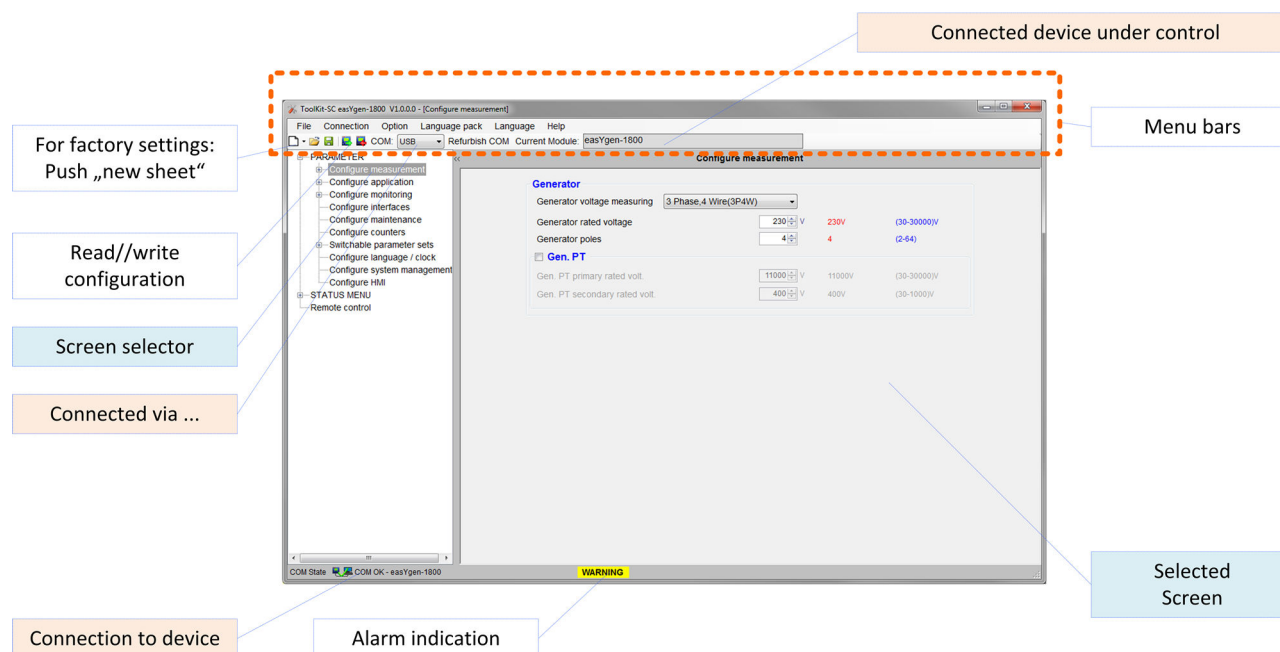

*ToolKit-SC is installed and connection between your computer and the easYgen device is established*

⇒ The ToolKit-SC home screen (see above) displays.

2. Click accept to read device configuration.

⇒ ToolKit-SC displays the current device configuration settings and values.

3. Use the lower left area to select a screen/page to edit.

4. The button on the lower right side lets you select the screen.

5. To import your current ToolKit-SC configuration into the device, click on "Write config(W)" in the menu bar.



*Your are asked to enter a password. Additionally, the splash screen image can be selected.*

⇒ The settings are transmitted to the device and immediately become active.

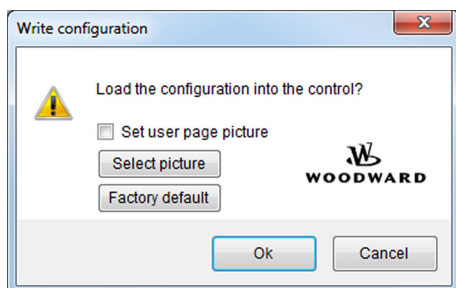

Fig. 11: ToolKit-SC: write configuration

## 4.2 Parameters

### 4.2.1 Parameter Menu Structure

#### Parameter Menu



*Parameters of both HMI (front panel access) and ToolKit-SC are not presented in the same order.*

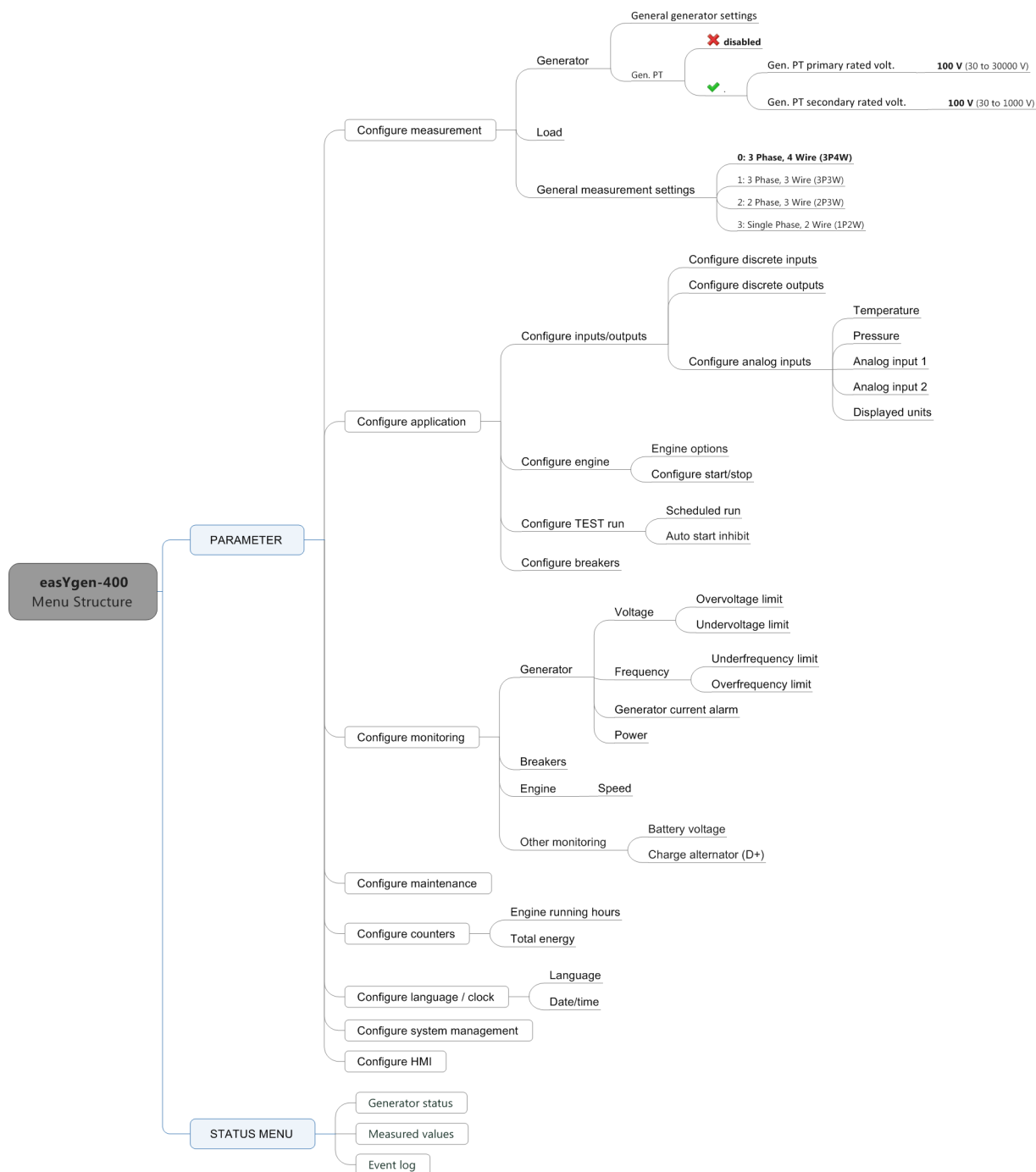

Fig. 12: Menu Structure easYgen-400 - overview

## 4.2.2 Parameter Settings Menu--HMI Access

1. ➤ Press the "RIGHT" button.  
⇒ The main menu opens.
2. ➤ Select "1 set parameters"
3. ➤ Enter a password for the parameter settings screen.

## Configuration

Parameters > Configure Measurement

4. Press return.



*Factory default: 0500*

⇒ First parameter from the list appears.

5. Navigate until the desired parameter can be edited e.g. using the "Right" button

6. Edit parameter.

7. Press the "Set/Confirm" button

⇒ The parameter is updated immediately!



*The settings can be saved to the device by pressing the "Write" button!*



*The editor screen is closed automatically after five minutes of inactivity.*



*The setting process is aborted immediately when pushing the "Stop" button!*

### 4.2.3 Configure Measurement

#### Generator Settings

*"PARAMETER → Configure measurement → Generator"*

Items	Parameters	Defaults	Description
<b>General generator settings</b>			
Monitoring	On Off	<b>On</b>	<b>On</b> Monitoring is enabled. <b>Off</b> Monitoring is disabled.
Generator poles	(2 to 64)	<b>4</b>	Number of generator poles. Used for calculating starter rotation speed if no speed sensor is used.
Generator fail delay time	(0.0 to 20.0) s	<b>10.0 s</b>	
<b>Gen. PT</b>	Unchecked: Disabled Checked: Enabled	<b>Disabled</b>	<b>Notes</b> Access to parameters below only if "enabled"
Gen. PT primary rated volt.	30 to 30000 V	<b>100 V</b>	Primary value from the used potential transformer (PT)
Gen. PT secondary rated volt.	30 to 1000 V	<b>100 V</b>	Secondary value from the used potential transformer (PT)

**Load Settings***"PARAMETER → Configure measurement → Load"*

Items	Parameters	Defaults	Description
<b>Load</b>			
Load CT primary rated current	(5 to 6000)/5	<b>500/5</b>	The ratio of external CT
Load rated current	(5 to 6000) A	<b>500 A</b>	Generator's rated current, standard of load current

**General Measurement Settings***"PARAMETER → Configure measurement  
→ General Measurement settings"*

Items	Parameters	Defaults	Description
<b>Voltage measuring</b>			
Voltage measuring	0: 3 Phase, 4 Wire (3Ph4W) 1: 3 Phase, 3 Wire (3Ph3W) 2: 2 Phase, 3 Wire (2Ph3W) 3: Single Phase, 2 Wire (1Ph2W)	<b>3 Phase, 4 Wire (3Ph4W)</b>	<p><b>3 Phase, 4 Wire (3Ph4W):</b> The measurement is performed line-neutral and line-line: VL12, VL23 and VL31 VL1N, VL2N and VL3N</p> <p><b>3 Phase, 3 Wire (3Ph3W) :</b> The measurement is performed line-line. VL12, VL23 and VL31</p> <p><b>2 Phase, 3 Wire (2Ph3W)</b> The measurement is performed line-neutral and line-line: VL12 VL1N and VL2N</p> <p><b>Single Phase, 2 Wire (1Ph2W)</b> The measurement is performed line-neutral: VL1N</p>

**4.2.4 Configure Application****4.2.4.1 Configure Inputs and Outputs****4.2.4.1.1 Configure Discrete Inputs****Configure Discrete Inputs***"PARAMETER → Configure application  
→ Configure discrete inputs"*

## Configuration

Parameters > Configure Application > Configure Inputs and Outpu...

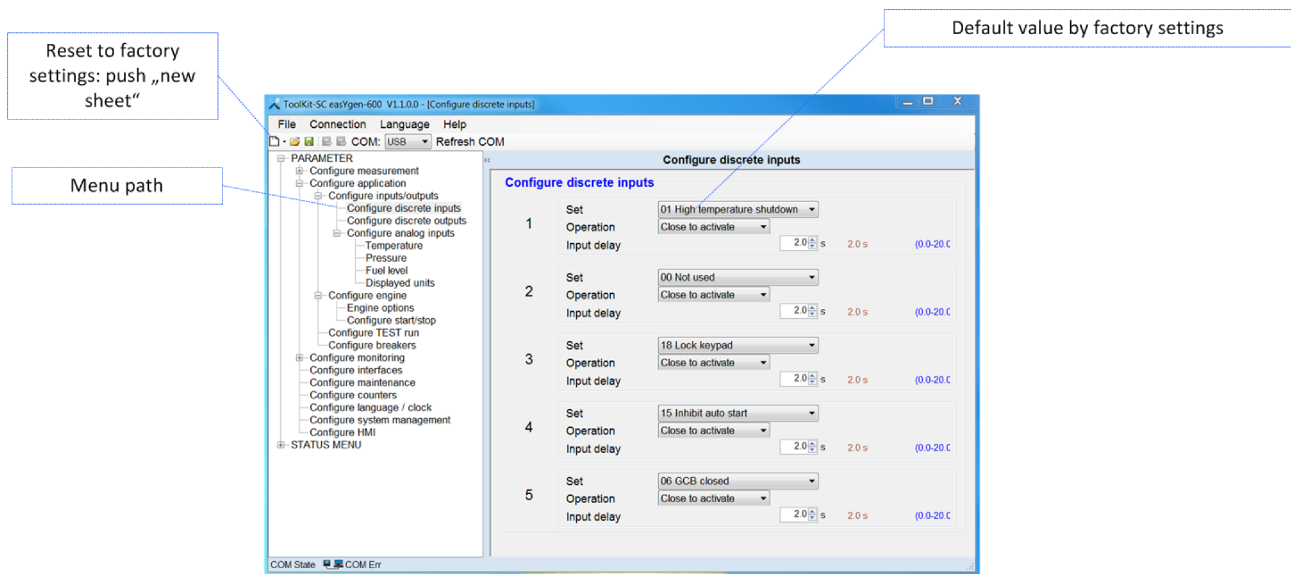

Fig. 13: ToolKit-SC: Config discrete inputs

Items	Parameters	Defaults	Description
<b>Configure discrete inputs ...</b>			
Set	00 to 23	01 High temperature shutdown	Default of discrete input 1
		02 Low oil pressure shutdown	Default of discrete input 2
		10 Start request in AUTO	Default of discrete input 3
		11 Fuel level warning	Default of discrete input 4
		12 Coolant level warning	Default of discrete input 5
		<b>Notes</b>	
See chapter <a href="#">Chapter 4.3.2 "Programmable Inputs"</a> on page 5 for details			
Operation	Close to activate Open to activate	Close to activate	<b>Close to activate (N.O.):</b> The discrete input is analyzed as "enabled" by energizing the input (normally open).
			<b>Open to activate (N.C.):</b> The discrete input is analyzed as "enabled" by de-energizing the input (normally closed).
Input delay	0.0 to 20.0 s	2.0 s	The input status must be valid for this period of time before it is released

#### 4.2.4.1.2 Configure Discrete Outputs

**Configure discrete outputs**

1

2

3

4



Fig. 14: DC Outputs

"PARAMETER → Configure application  
→ Configure discrete outputs"

Items	Parameters	Defaults	Description
<b>Configure discrete outputs</b>			<b>Notes</b> For discrete outputs 1 to 4:
(Map Programmable Output)	00 to 26	02 Stop solenoid	Default of discrete output 1
		03 Idle control	Default of discrete output 2
		05 Close GCB	Default of discrete output 3
		06 -	Default of discrete output 4

#### 4.2.4.1.3 Configure Analog Inputs



"PARAMETER → Configure application  
→ Configure inputs/outputs → Configure analog inputs → ..."



Items	Parameters	Defaults	Description
<b>Temperature</b>			
Type	00 to 14	08 SGX	See chapter <a href="#">Chapter 4.3.1 "Programmable Sensors"</a> on page 50
If a type (01 or higher) with curve is selected:	Curve can be loaded ... 	-/-	<b>Notes</b> For temperature curve management and customization.
	... and/or edited 	(curve)	
Wire break alarm	Warn Shutdown None	Warn	Alarm type to be released if a wire break is detected

## Configuration

Parameters > Configure Application > Configure Inputs and Outpu...

Items	Parameters	Defaults	Description
High limit shutdown	Immediate Stop Cooling Down Warning	Immediate Stop	Reaction from the device if the high temperature alarm is triggered.  Immediate Stop: The GCB opens and the engine stops immediately  Cooling down: The GCB opens and the engine stops after the configured cooldown time.
Limit	80 to 140 °C	98 °C (208 °F)	Release the alarm when the sensor value is identical to or higher than this value.
<b>Engine heater control</b>	enabled/disabled	disabled	<b>Notes</b> "enabled": The following related settings will be taken into account
On	0 to 300 °C	50 °C (122 °F)	The engine heater control is switched on if the actual temperature is lower than the configured threshold.
Off	0 to 300 °C	55 °C (131 °F)	The engine heater control is switched off if the actual temperature is higher than the configured threshold.
Delay	0 to 3600 min	60 min	Maximum activation time from the engine heater control. With a value of 0 the max. runtime is disabled.



Items	Parameters	Defaults	Description
<b>Pressure</b>			
Type	00 to 14	08 SGX	See chapter <a href="#">Chapter 4.3.1 "Programmable Sensors"</a> on page 50
If a type (01 or higher) with curve is selected:	Curve can be loaded ...  ... and/or edited 	-/ (curve)	<b>Notes</b> For pressure curve management and customization.
Wire break alarm	Warn Shutdown None	Warn	Alarm type to be released if wire break is detected
Low limit action	Immediate Stop Cooling Down Warning	Immediate Stop	Reaction from the device if the high temperature alarm is triggered.  Immediate Stop: The GCB opens and the engine stops immediately  Cooling down: The GCB opens and the engine stops after the configured cooldown time.
Limit	0 to 400 kPa	103 kPa (14.94 psi, 1.03 bar)	Release the alarm when sensor value is same or lower than this value and Delay time is over

Items	Parameters	Defaults	Description
<b>Analog input 1 with option "Fuel level"</b>			
Input type	Configure discrete input 4 Fuel level	Configure discrete input 4	
Type	00 to 07	03 SGD	See chapter <a href="#">Chapter 4.3.1 "Programmable Sensors"</a> on page 50
If a type (02 or higher) with curve is selected:	Curve can be loaded ...  ... and/or edited 	-/ (curve)	<b>Notes</b> For fuel level curve management and customization.



Parameters &gt; Configure Application &gt; Configure Inputs and Outpu...

Items	Parameters	Defaults	Description
Low limit warning	0 to 100 %	10 %	Warning alarm will sound when sensor value is below the threshold.
Low limit shutdown	0 to 100 %	5 %	Shut down when the sensor value is below the threshold.
<b>Fuel pump control</b>			
On	0 to 100 %	25 %	Release the alarm when sensor value is identical to or below this value and the delay time is over
Off	0 to 100 %	80 %	Cancel the alarm when sensor value is identical to or below this value and the delay time is over
<b>Fuel tank capacity enable</b>	Enabled/disabled	Disabled	Disabled: Fuel tank capacity is displayed in %. Enable: Additional visualization of fuel tank capacity in litres (L)
Fuel tank capacity	0 to 10000 L	1000 L	Select the respective fuel tank capacity in litres (L).

Items	Parameters	Defaults	Description
<b>Analog input 2</b>			
Input type	Configure discrete input 5 Temperature Pressure Fuel level	Configure discrete input 5	
Curve type	00 to 07	03 SGD	See chapter <a href="#">Chapter 4.3.1 "Programmable Sensors"</a> on page 50
If a type (01 or higher) with curve is selected:	Curve can be loaded ...  ... and/or edited 	-/ (curve)	<b>Notes</b> For fuel level curve management and customization.
Low limit shutdown	0 to 100 %	5 %	Shut down when sensor value is below the threshold.
Low limit warning	0 to 100 %	10 %	Warning alarm will sound when sensor value is below the threshold.

Items	Parameters	Defaults	Description
<b>Displayed units</b>			
Temperature	°C °F	°C	Select local temperature unit for display
Pressure	kPa psi bar	kPa	Select local pressure unit for display

## Configuration

Parameters > Configure Application > Configure Engine

### 4.2.4.2 Configure Engine

*"PARAMETER → Configure application → Configure engine"*

Items	Parameters	Defaults	Description
<b>Engine options</b>			
Engine Type	00 to 39	00 Conventional Engine	Default: Conventional genset (not J1939). When connected to J1939 engine, choose the corresponding type, see chapter <a href="#">Chapter 7.1 "J1939" on page 69</a> .
MPU flywheel teeth	10 to 300	118	Tooth number of one 360° rotation, to determine crank disconnect conditions and inspect engine speed
ECU Inc. / Dec. steps	1 to 20 r/min	5 r/min	The speed offset (J1939) works in combination with input sources (increase/decrease speed). The input sources can be configured to discrete inputs in order to adjust the speed of the engine. With an additional parameter the speed variation can be adjusted (Inc. / Dec. step 1 to 20 rpm) but the overall offset is limited to ±10 % from rated speed.  The speed offset is active as long as the engine is in operation and is automatically reset to zero if the engine stops.
<b>Configure Start/Stop</b>			
Start Attempts	1 to 10 times	3	Max. number of crank attempts. When reaching this number, controller will send start failure signal.
<b>Start timers</b>			
Start delay	0 to 3600 s	1 s	Time from remote start signal is active to start genset
Fuel output time	1 to 60 s	1 s	Time delay between fuel relay activation and starter.
Preglow time	0 to 300 s	0 s	Time of pre-powering heat plug before starter is powered up
Starter time	3 to 60 s	8 s	Time of starter power up
Start pause time	3 to 60 s	10 s	The waiting time before second power up when engine start fails
Engine monitoring delay time	1 to 600 s	10 s	Alarms for low oil pressure, high temperature, under speed, under frequency /voltage, charge fail are inactive.
Start idle time	0 to 3600 s	0 s	Idle running time of genset when starting.
Warm up time	0 to 3600 s	10 s	Warming time between genset switch on and normal running
<b>Stop timers</b>			
Stop delay	0 to 3600 s	1 s	Time from remote start signal is active to start genset
Cool down time	0 to 3600 s	10 s	Radiating time before genset stop after unloading
Stop idle time	0 to 3600 s	0 s	Idle running time when genset stops
Stop solenoid hold	0 to 120 s	20 s	The time of powering up the electromagnet during stop procedure
Stop time of engine	0 to 120 s	0 s	A time accepted for a regular stop to standby. Activated once the "fail to stop delay" time (e.g. crank disconnect conditions contain oil pressure, and oil pressure drops quite slowly if genset stops) is reached.
<b>Pulse time</b>			
Speed raise pulse	0 to 20 s	0.2 s	The "speed raise pulse time" relates to the output "24 Speed raise pulse" and is active for the configured time after the starting sequence "start idle".
Speed drop pulse	0 to 20 s	0.2 s	The speed drop pulse time relates to the output "25 Speed lower pulse" and is active for the configured time after the stop sequence "stop idle".
<b>Crank disconnect</b>			
Firing speed RPM	enabled/disabled	enabled	

Items	Parameters	Defaults	Description
	0 to 3000 r/min	360 r/min	When the generator speed is higher than the set value, the starter will be disconnected. See the installation instructions.
Firing speed Hz	enabled/disabled	enabled	
	0.0 to 30 Hz	14.0 Hz	When generator frequency higher than the set value, starter will be disconnected. See the installation instructions.
Oil Pressure	enabled/disabled	disabled	
	0 to 400 kPa	200 kPa	When generator oil pressure higher than the set value, starter will be disconnected. See the installation instructions.
Disconnect OP time	0 to 20 s	0 s	The starter will be disconnected if the oil pressure is higher than the set value for the configured time.

#### 4.2.4.3 Configure TEST Run

*"PARAMETER → Configure application → Configure TEST run"*

Items	Parameters	Defaults	Description
Scheduled run	enabled/disabled	disabled	<b>Notes</b> "enabled": The following related settings will be taken into account
Run mode	Off load On load	Off load	
Schedule period	Monthly Weekly Daily Custom weekly	Monthly	<b>Notes</b> "Custom weekly": A table with 16 x setting blocks displays, each with ... <ul style="list-style-type: none"> <li>■ Start time (weekly) to select a week day</li> <li>■ Start time (hh:mm)</li> <li>■ Duration (m)</li> </ul> The TEST run is disabled if the duration is "0" minutes. Max. duration is 30000 minutes.
Time (Day)	1 to 31	1	"Monthly": Select a week day
	Sunday, to Saturday	Sunday	"Weekly": Select a week day
Time (hour)	0 to 24 h	0 (o'clock)	Define the start time (hour)
Time (minute)	0 to 59	0	Define the start time (minute)
Duration	0 to 30000 min	30 min	Select the duration for a scheduled run
Auto start inhibit	enabled/disabled	disabled	<b>Notes</b> "enabled": The following related settings will be taken into account
Schedule period	Monthly Weekly Daily	Monthly	
Time (Day)	1 to 31	1	"Monthly": Select a week day
	Sunday, to Saturday	Sunday	"Weekly": Select a week day
Time (hour)	0 to 24 h	0 (o'clock)	Define the start time (hour)
Time (minute)	0 to 59	0	Define the start time (minute)
Duration	0 to 30000 min	30 min	Select the duration for a scheduled run

## Configuration

Parameters > Configure Monitoring > Monitoring Generator

### 4.2.4.4 Configure Breakers

*"PARAMETER → Configure application → Configure breakers"*

Items	Parameters	Defaults	Description
<b>Configure breakers</b>			
Manual mode ATS	Key switch Auto switch	Default: Key switch.	Handling of the breaker in MAN mode. Key switch: Opens/closes breaker with the buttons. Auto switch: The controller logic is used to open/close the breaker and the related buttons are disabled.
Closing time	0.0 to 10.0 s	5.0 s	Pulse width of generator switch ON. <b>Notes</b> This is the duration from the closing pulse for GCB as well. If the time is configured to "zero" the closing pulse acts as a steady pulse.
Opening time	0.0 to 60.0 s	3.0 s	Pulse width of generator switch OFF <b>Notes</b> This is the duration from the opening pulse for GCB as well.

## 4.2.5 Configure Monitoring

### 4.2.5.1 Monitoring Generator

#### Monitoring Voltage

*"PARAMETER → Configure monitoring → Generator → Voltage"*

Items	Parameters	Defaults	Description
<b>Overvoltage</b>			
Limit	30 to 60000 V	264 V	Release the alarm when generator voltage is same or higher than this value
<b>Undervoltage</b>			
Limit	30 to 60000 V	196 V	Release the alarm when generator voltage is same or lower than this value

#### Monitoring Frequency

*"PARAMETER → Configure monitoring → Generator → Frequency"*

Items	Parameters	Defaults	Description
<b>Overfrequency</b>			
Limit	0.0 to 75 Hz	57.0 Hz	Release the alarm when generator frequency is same or higher than this value.
<b>Underfrequency</b>			
Limit	0.0 to 75 Hz	45.0 Hz	Release the alarm when generator frequency is same or lower than this value.

### Monitoring Generator Current Alarm

"PARAMETER → Configure monitoring → Generator → Generator current alarm"

Items	Parameters	Defaults	Description
<b>Generator current alarm</b>			
Limit	50 to 130 %	120 % (600 A)	Release the alarm when sensor value is same or higher than this value and Delay time is over
Type	Define Time IDMT (Inverse definite minimum time)	Define time	
If Type is "Define Time": Delay	0 to 3600 s	30 s	The alarm status change must be valid for this period of time before it is released
If Type is "IDMT ...": Multiply	1 to 36	36	"Multiply" defines the grade of reaction on the ratio of generator current to overcurrent setting. A low value means fast reaction (short delay time); the greater the value the slower reaction because longer delay time.

### Monitoring Power

"PARAMETER → Configure monitoring → Generator → Power"

Items	Parameters	Defaults	Description
<b>Overload</b>	enabled/disabled	disabled	<b>Notes</b> "enabled": The following related settings will be taken into account
Action	Not used Warn Shutdown	Not used	Alarm type to be released if wire break is detected
Limit	0 to 6000 kW	304 kW	Release the alarm when sensor value is same or higher than this value and Delay time is over
Return	0 to 6000 kW	290 kW	Reset the alarm when the active power is lower than this value
Delay	0 to 3600 s	5 s	The alarm status change must be valid for this period of time before it is released

#### 4.2.5.2 Monitoring Breakers

### Monitoring Breakers

"PARAMETER → Configure monitoring → Breakers"

Items	Parameters	Defaults	Description
Enable breaker feedback monitoring	Enabled/disabled	Disabled	When breaker feedback monitoring is enabled, the device uses the configured discrete inputs for the breaker status.
Check fail warn(ing)	Enabled/disabled	Disabled	Enable the breaker feedback monitoring. This requires the "Enable breaker feedback monitoring".
Check time	0.0 to 20.0 s	5.0 s	Breaker monitoring delay time. After the configured check time, a breaker failure alarm sounds.

## Configuration

Parameters > Configure Monitoring > Other Monitoring

### 4.2.5.3 Monitoring Engine

#### Monitoring Speed

*"PARAMETER → Configure monitoring → Engine → Speed"*

Items	Parameters	Defaults	Description
<b>Overspeed shutdown</b>			
Limit	0 to 6000 r/min	1710 r/min	Release the alarm when the MPU speed is same or higher than this value.
<b>Underspeed shutdown</b>			
Limit	0 to 6000 r/min	1200 r/min	Release the alarm when the MPU speed is same or lower than this value.
<b>Loss of speed signal</b>			
Delay	0 to 20 s	5 s	Release the alarm when the speed signal (MPU) is not available for this period of time.

### 4.2.5.4 Other Monitoring

#### Monitoring Battery Voltage

*"PARAMETER → Configure monitoring → Engine → Other monitoring → Battery voltage"*

Items	Parameters	Defaults	Description
<b>Overvoltage</b>			
Limit	12.0 to 40.0 V	33.0 V	Release the alarm when sensor value is same or higher than this value
<b>Undervoltage</b>			
Limit	4.0 to 30.0 V	8.0 V	Release the alarm when sensor value is same or lower than this value

#### Monitoring Charge Alternator (D+)

*"PARAMETER → Configure monitoring → Engine → Other monitoring → Charge alternator"*

Items	Parameters	Defaults	Description
<b>Charge alternator (D+)</b>			
Charge alternator fail	0.0 to 30.0 V	6.0 V	Release the alarm when the charge alternator signal (D+) is not available

## 4.2.6 Configure Maintenance

“PARAMETER → Configure maintenance”

Items	Parameters	Defaults	Description
<b>Maintenance</b>			
Password	0 to 9999	(0-9999)	<b>Notes</b> Customer-specific password for changing the maintenance interval through the HMI.
Select Action	Not used Warn Shutdown	Not used	Defines the alarm class if the maintenance is triggered.
Interval	0 to 5000 h	250 h	Maintenance interval based on operation hours.
Time	Push icon	(current date)	Maintenance based on internal time.

## 4.2.7 Configure Counters

“PARAMETER → Configure counters”

Items	Parameters	Defaults	Description
<b>Engine run</b>			
Time	0 to 65534 hours	0 hours	Preset value
	0 to 59 min	0 min	Preset value
	Set (push button)		PUSH: Preset time is written to the connected easYgen
Start	0 to 65534	0	Preset value: Number of starts
	Set (push button)		PUSH: Preset number of starts is written to the connected easYgen
<b>Current module</b>	Display values of the device		Updated by pushing one of the set buttons above
Total run time			Total engine run time
Total start times			Total number of starts
<b>Total energy</b>			
kW	0 to 9999999.9 kW	0.0 kW	
	Set (push button)		PUSH: Preset kW value is written to the connected easYgen
<b>Current module</b>	Display values of the device		Displaying the values of the device
kW energy			Updated by pushing the set button (above)

## Configuration

Parameters > Configure System Management

### 4.2.8 Configure Language / Clock

*"PARAMETER → Configure language / clock"*

Items	Parameters	Defaults	Description
Language	English	English	<b>Notes</b> To upload a customer specific language file, see ToolKit-SC menu <i>"Language pack"</i>
	Chinese		
	Spanish		
	Russian		
	Portuguese		
	Turkish		
	Polish		
	French		
<b>Date/Time</b>			
<b>Set value</b>			
Date	Push icon	(current date)	Calendar sub module will be opened: DD.MM.YYYY
Time	Time display	(current time)	Time sub module enable comfortable setting time value: hh:mm:ss
Set	Push button		Write value to the easYgen device
Use PC time	Push button		Write PC time to the easYgen device
<b>Current module</b>	Date (YYYY-MM-DD)	(actual value)	Display device's value
	Time (hh:mm:ss)		

### 4.2.9 Configure System Management



*"PARAMETER → Configure system management"*

Items	Parameters	Defaults	Description
<b>Configure system management</b>			
Password	enabled/disabled	disabled	Enabled: <ul style="list-style-type: none"> <li>■ Type in new password</li> <li>■ "eye symbol": switch between visible number and placeholder stars</li> </ul>
	0 to 9999	0500	Factory setting for write access from ToolKit-Sc to the easYgen
Startup in mode	Stop mode	Stop mode	
	Manual mode		
	Auto mode		



## 4.2.10 Configure HMI

*"PARAMETER → Configure HMI"*

Items	Parameters	Defaults	Description
Activate start-up logo	Enabled/disabled	Disabled	Disabled: No logo is shown at startup
Start-up logo duration	0 to 3600 s	10 s	Duration of start-up logo time at device startup
Set start-up logo	Push button		Push: Opens sub menu to select a picture file (132 x 64 pixels black/white recommended) and upload it to the device
Select	Default theme OEM plant theme Terminal users theme		Select pre-defined theme or user-defined HMI theme. Theme configuration is disabled in "Default theme" mode.
If "OEM plant theme" or "Terminal users theme" is selected:	Load theme from file  Save theme to file 		Customize up to 12 screens by selecting options from the menu on the right and re-order them with drag and drop. Drag the options up or down to set the desired order. Remove an option by hitting the respective close button or dropping a different option on it.  Once you have created a theme, save it to file by hitting the save button.  Load a theme from file by hitting the load button.
Default reset	Push button		Reset theme to default settings
Activate start-up logo	Enabled/disabled	Enabled	Show customer's logo during start-up?

## Configuration

Selectable Inputs/Outputs/Se... > Programmable Sensors

### 4.3 Selectable Inputs/Outputs/Sensors

#### 4.3.1 Programmable Sensors

##### Selection

Sensor	Description	Remark
Temperature Sensor	<b>0 Not used</b> 1 User configured (Resistance) 2 VDO 3 SGH 4 SGD 5 CURTIS 6 DATCON 7 VOLVO-EC 8 SGX 9 to 10 Reserved 11 DIGITAL CLOSED 12 DIGITAL OPEN 13 to 14 Reserved	Defined resistance range is (0 to 6) KΩ. Default is "0 Not used".
Pressure Sensor	<b>0 Not used</b> 1 Custom Res Curve 2 VDO 3 SGH 4 SGD 5 CURTIS 6 DATCON 7 VOLVO-EC 8 SGX 9 to 10 Reserved 11 CLOSED 12 OPEN 13 VDO 5 bar 14 Reserved	Defined resistance range is (0 to 6) KΩ. Default is "0 Not used".
Fuel Level Sensor	0 Not used 1 User configured (Resistance) 2 SGH 3 SGD 4 to 5 Reserved 6 DIGITAL CLOSED 7 DIGITAL OPEN	Defined range of resistance is (0 to 6) KΩ. Default is "0 Not used".

**Configuration/Setting**

*When reselecting sensors, the sensor curve will be transferred to the standard value. For example, if a temperature sensor is SGX (120°C resistor type), its sensor curve is SGX (120°C resistor type); if you select the SGD (120°C resistor type), the temperature sensor curve is SGD curve.*

*If there is a difference between standard sensor curve and used sensor, it can be adjusted in the "curve type" menu.*

*When entering the the sensor curve values, the X value (resistor) must be in sequence from small to large, otherwise, mistakes can occur.*

*If you select the option None under sensor type, the sensor curve does not work.*

*If the corresponding sensor has an alarm switch only, set this sensor to "None". Otherwise, shut-down or warnings can occur.*

**4.3.2 Programmable Inputs**

*The programmable inputs are all active, if connected to ground (B-).*

Each input needs an alarm type and a release condition definition:

No.	Items	Description
0	Not Used	
1	High Temp. Alarm	If the signal is active after safety run on delay over, the genset will immediately activate a shutdown alarm.
2	Low OP Alarm	
3	Auxiliary Alarm	Only warning, no shutdown.
4	Aux. Shutdown Alarm	If the signal is active, genset will immediately alarm to shutdown.
5	Coolant To Stop	When a high temperature occurs while the engine running and the input is active, the controller will stop after high speed cooling; When the input is disabled, the controller will stop immediately.
6	Gens Closed Input	Connect to auxiliary port of gen load breaker.
7	Mains Closed Input	Connect to auxiliary port of mains load breaker.
8	High Temp. Inhibit	When active, high oil temperature stop is inhibited. See Note2 of Table1 for more information.
9	Low Oil Pressure Inhibit	When active, low oil pressure stop is inhibited. See Note3 of Table1 for more information.
10	Remote Start Input	In Auto mode, when the input is active, the genset can be started and with load after genset is OK; when the input is inactive, the genset will stop automatically.

## Configuration

Selectable Inputs/Outputs/Se... > Programmable Outputs

No.	Items	Description
11	Low Fuel Level Warn	Connected to sensor digital input. The controller sends a warning alarm signal when active.
12	Low Water Level Warn	
13	Low Fuel Level Shutdown	Connected to sensor digital input. The controller sends a shutdown alarm signal when active.
14	Low Water Level Shutdown	
15	Auto Start Inhibit	In Auto Mode, when the input is active, no matter if mains is normal, genset will not start. If genset is running normally, the stop process will not be executed. When the input is disabled, the genset will automatically start or stop depending on the mains being normal or not.
16	Remote Control Input	All buttons on panel are inactive except the four menu buttons to the right of the display. Additionally, remote mode is displayed on the LCD. Remote mode can switch module mode and start/stop operation via panel buttons.
17	Failed To Charge	Connect to failed to charge output.
18	Panel Lock	All buttons in panel are inactive except
19	Alarm Mute	Can prohibit "Audible Alarm" output when input is active.
20	Idle mode	Under voltage/frequency/speed protection is inactive
21	Enable 60Hz	Set " <i>System rated frequency</i> " to default of 60 Hz (e.g. used for CANBUS engine)
22	Raise speed (ECU)	If ECU type is generic J1939: CAN request increases engine speed in corresponding speed steps
23	Lower speed (ECU)	If ECU type is generic J1939: CAN request decreases engine speed by corresponding speed steps

### 4.3.3 Programmable Outputs

No.	Items	Description
0	Not Used	Output is disabled when this item is selected.
1	Centralized Alarm	Include all shutdown alarms and warning alarms. When a warning alarm occurs, the alarm will not self-lock automatically; When a shutdown alarm occurs, the alarm will self-lock until the alarm is reset.
2	Stop solenoid	Used for the genset with stop solenoid. Pick-up when idle speed is over while disconnect when ETS delay is over.
3	Idle Control	Used for the genset with idle speed. Pick-up when crank while disconnect when enter into warming up. Pick-up when stop idle while disconnect when genset stop completely.
4	Preglow	Close before started and disconnect before powered on
5	Close GCB	When close time is set to 0 s, it is continuous closing
6	Reserved	
7	Open GCB	When close time is set to 0, "open breaker" is disabled

No.	Items	Description
8	Raise speed	Pick-up when enter into warming up time. Disconnect when raise speed auxiliary input active
9	Lower speed	Pick-up when enter into stop idle or ETS solenoid stop (shutdown alarm). Disconnect when droop speed auxiliary input active
10	Generator running	Output when genset is running normally, disconnect when rotating speed is lower than engine speed after fired
11	Fuel Pump Control	Pick-up when the fuel level lower than the open threshold or low fuel level warning is active; disconnect when the fuel level over the close threshold and the low fuel level warning input is disabled
12	In operation	Output when it enters into warming up time, and disconnect after cooling
13	Operation mode AUTO	The controller is in Auto Mode
14	Stopping alarm	Output when shutdown alarm occurs and open when alarm is reset.
15	Centralized alarm	When shutdown alarm and warn alarm, audible alarm is set to 300s. In audible alarm output duration, when panel any key or "alarm mute" input is active, it can remove the alarm.
16	Heater control	It is controlled by cooler of temperature sensor's limited threshold
17	Fuel	Action when genset is starting and disconnect when stop is completed
18	Starter	Genset output in start output status and open in other status
19	ECU Stop	Used for ECU engine and control its stop
20	ECU Power Supply	Used for ECU engine and control its power
21	ECU Warning Alarm	Indicate ECU sends a warning signal
22	ECU Shutdown Alarm	Indicate ECU sends a shutdown signal
23	ECU timeout alarm	Indicate controller does not communicate with ECU
24	Speed raise pulse	HIGH for the pre-set " <i>rise speed pulse time</i> " after genset enters into high-speed warming period and before stop idling
25	Speed lower pulse	HIGH for the pre-set " <i>drop speed pulse time</i> " after entering stop idling
26	Reserved	

## 4.4 Status Menu

### General notes

Both HMI and ToolKit-SC offer status information.

### 4.4.1 HMI Status Screens

HMI displays the following status screens:

- Status (home)
- Generator

## Configuration

Status Menu > ToolKit-SC Status Screens

- Load
- Engine 1
- Engine 2
- Status
- Alarm
- home screen etc.

### 4.4.2 ToolKit-SC Status Screens

#### General notes

ToolKit-SC lets you access status information via the following screens:

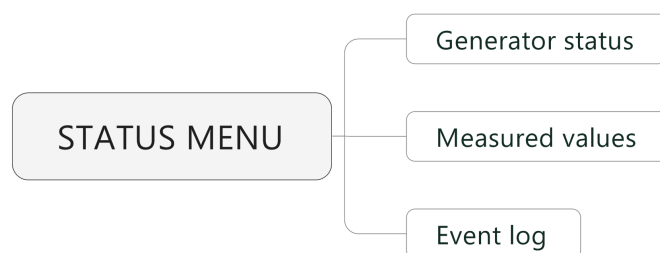

Fig. 15: easYgen-x400 status screens

#### Generator Status

*"PARAMETER → STATUS MENU → Generator status"*

Items	Parameters	Description
Engine info	Engine speed, Battery volt, Charger volt D+	
Sensor info	Engine temp, Oil pressure, Fuel level	Selection of ECU data via J1939.
More info	Coolant pressure, Coolant level, Fuel pressure, Fuel temp, Turbo pressure, Oil temp, Inlet temp, Fuel consume, Exhaust temp, Total consume	
Alarms	Current Alarms and Warning	Lists of current alarms and warnings
(Digital) Inputs	01 High temperature shutdown, 02 Low oil pressure shutdown, 10 Start request in AUTO, 11 Fuel level warning, 12 Coolant level warning	
(Digital) Outputs	02 Stop solenoid, 03 Idle control, 05 Close GCB, 06 Close MCB Fuel relay, Start relay	
Accumulation (run)	Time, Starts	
Next maintenance time	Time	
Engine hours	Time	
Generator status	Gen status	
Mains status	Overvoltage, Undervoltage, Loss of phase	

**Measured Values***"PARAMETER → STATUS MENU → Measured values"*

Items	Parameters	Description
<b>Electricity quantity</b>		
Mains	-/-	
Generator	L1, L2, L3, L1-2, L2-3, L3-1, L1Phase, L2Phase, L3Phase, Frequency	
Current (A)	L1, L2, L3	
Active power (kW)	L1, L2, L3, Total	
Reactive power (kvar)	L1, L2, L3, Total	
Apparent power (kVA)	L1, L2, L3, Total	
Power factor	L1, L2, L3, Avg	

**Event Log and Version***"PARAMETER → STATUS MENU → Event log and version"*

Items	Parameters	Description
Module Info	Model, Hardware Version, Software Version, Issue Date	
Event log	<p><b>Fixed view of:</b> No., Event type</p> <p><b>Columns "move behind" visible part of the screen:</b> Event Item, Date, Time,             ((Mains control is not supported by this model, so all "Mains" values are "0":)  <i>Mains Uab (V) / Ubc (V) / Uca (V), Mains Ua (V), Mains Ub (V), Mains Uc (V), Mains f (Hz),</i>            Gens Uab (V) ..., Gens Ua (V) ..., Gens f(Hz),            Current Ia (A) ...,            Power (kW),            Speed (r/min),            Temp. (°C),            Press. (kPa),            Volt. (V)</p>	Event log report table. Shows the 99 latest events.
	Read log Clear Export to Txt	Push buttons to manage logged data

## Configuration

---

Status Menu > ToolKit-SC Status Screens



## 5 Operation

### 5.1 Front Panel: Operating and Display Elements

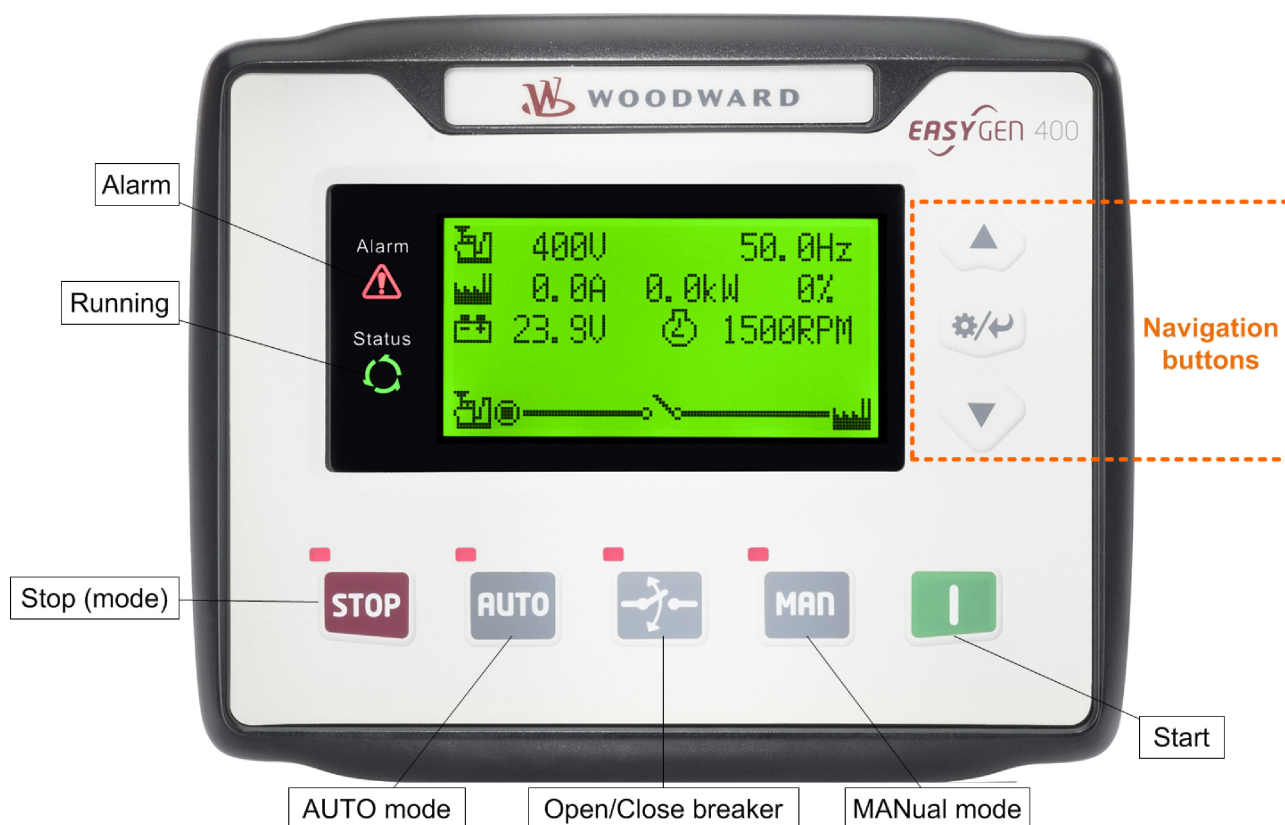







Fig. 16: easYgen-400

Icons	Keys	Description
	STOP	Auto/Manual mode: Stops running generator Stop mode: Resets alarm Lamp test (press at least 3 seconds)
<b>Notes</b>		
During stopping process, press this button again to stop generator immediately.		
	I (START)	MANual mode: Start genset
	MAN (Manual Mode)	Press this key and the controller enters into MAN mode
	AUTO (Automatic Mode)	Press this key and the controller enters into AUTO mode
	Open/Close breaker	Release breaker control in MAN mode. The navigation button "Up/Increase" is used to close the GCB. The navigation button "Down/Decrease" is used to open the GCB

## Operation

### Warning/Alarm Signaling

Icons	Keys	Description
	Up/Increase	1) Screen scroll 2) Settings menu: Up cursor and increase value in Close GCB in MAN mode
	Down/Decrease	1) Screen scroll 2) Settings menu: Down cursor and decrease value 3) Open GCB in MAN mode 4) Lamp test: Press button for 5 sec
	Right Set/Confirm	1) Mute horn 2) Settings menu: Hold button for 5 sec 3) Settings menu: select digit position
	Alarm	
	Status	



*In MANUAL mode:*

*Pressing **MAN** and **I** (START) simultaneously will force the generator to crank. Successful start will not be judged according to crank disconnect conditions, the operator needs to crank the starter motor manually; Once the engine has fired, the operator must release the button. Only then the start output will be deactivated, safety on delay will start.*



#### **WARNING!**

Users can change passwords. Please make note of the new password after changing it. If you forget the password, please contact Woodward services and send all device information on the "ABOUT" page of the controller for legitimation.

## 5.2 Warning/Alarm Signaling

The Alarm type is visualized with an "Alarm" LED located beside the display.

Alarm Indicator LED	Alarm Type
Slow flashing	Warning
Fast flashing	Shutdown or Trip Alarm
ON (permanently illuminated)	Common Alarm, acknowledged

## 5.2.1 Alarm Acknowledgment

### General notes

The alarm acknowledge handling is valid for following alarm classes

- Shutdown
- Trip/Stop
- Trip

### Mute Horn

Any new active alarm activates the horn and is made visible by the flashing Alarm LED.

After pressing the "Down/Decrease" button, the horn is deactivated and the Alarm LED changes from flashing to constantly active and stays active as long as any alarm is present. An additional active alarm reactivates the horn and the Alarm LED starts flashing again.

### Stop by alarm

The operation mode automatically changes to STOP if a stopping alarm is active (*"Shutdown"* or *"Trip/Stop"*).

### Acknowledge alarm

In case of alarm condition, pressing the STOP button will reset the alarm.

## 5.3 Operation Modes

### General notes

The easYgen offers three operation modes:

- AUTO
- MANUAL (MAN)
- STOP
- ... and an internal (non) operating phase during the start of the device itself

The operation mode can be initiated – provided the current settings allow for this funktion:

- directly by pressing the respective button on the front panel
- directly by click on the respective button on the ToolKit-SC remote screen
- via discrete inputs
- via interface

### 5.3.1 Operation Mode AUTO

#### General notes

In operation mode AUTO, both genset and breaker are under easYgen control. The start and stopping of the engine is managed automatically, along with opening/closing the breaker.

Depending on the settings and the application status, AUTO control can:

- supply load by generator
- start the engine
- stop the engine

## Operation

---

START/STOP Operation > Start engine to supply load

### 5.3.2 Operation Mode MANual

#### General notes

In operation mode MANual, both genset and breakers are independent of each other under easYgen control.

The starting and stopping of the engine are managed using the same procedure as in AUTO mode but without breaker control. Breakers can be opened and closed without taking care of load or genset state!

### 5.3.3 Operation Mode STOP

#### General notes

In operation mode STOP, the breaker is open and the engine is not running.



*This is a configurable operation mode, only. This is NO emergency STOP!*

## 5.4 START/STOP Operation

### 5.4.1 Start engine to supply load

The AUTO Start procedure is going through sub procedures with own timers.



*The remaining time of each of the timers initiated is shown in the display.*

*When started via "Remote Start (off Load)" input, start procedures is the same as described below but breaker close relay is deactivated.*

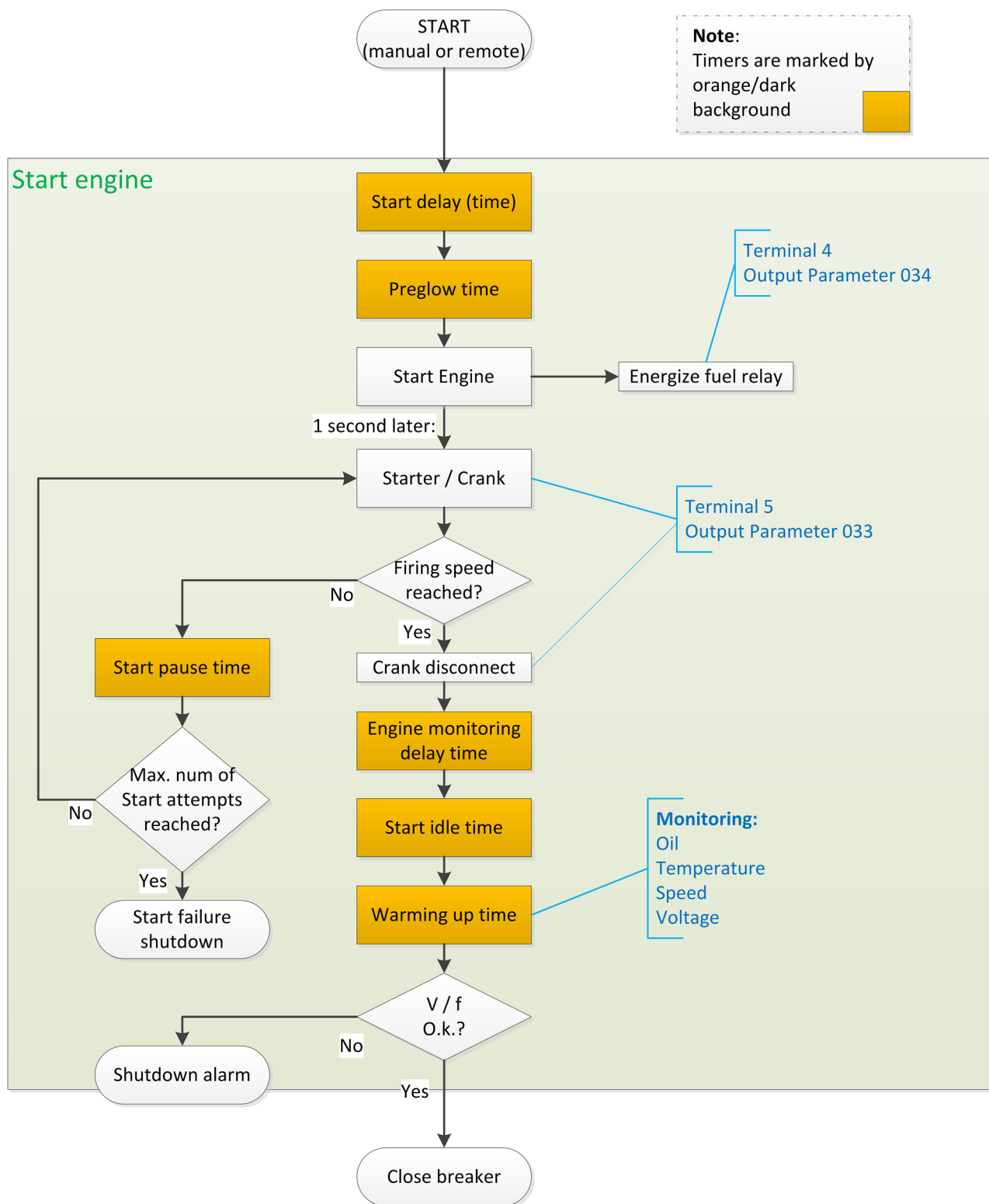

Fig. 17: Engine start procedure

## 5.4.2 Stop engine

The AUTO Stop procedure is going through sub procedures with own timers.

## Operation

---

START/STOP Operation > Stop engine



*The remaining time of each of the timers initiated is shown in the display.*

*When started via "Remote Stop (off Load)" input, start procedures is the same as described below but breaker open relay is deactivated.*

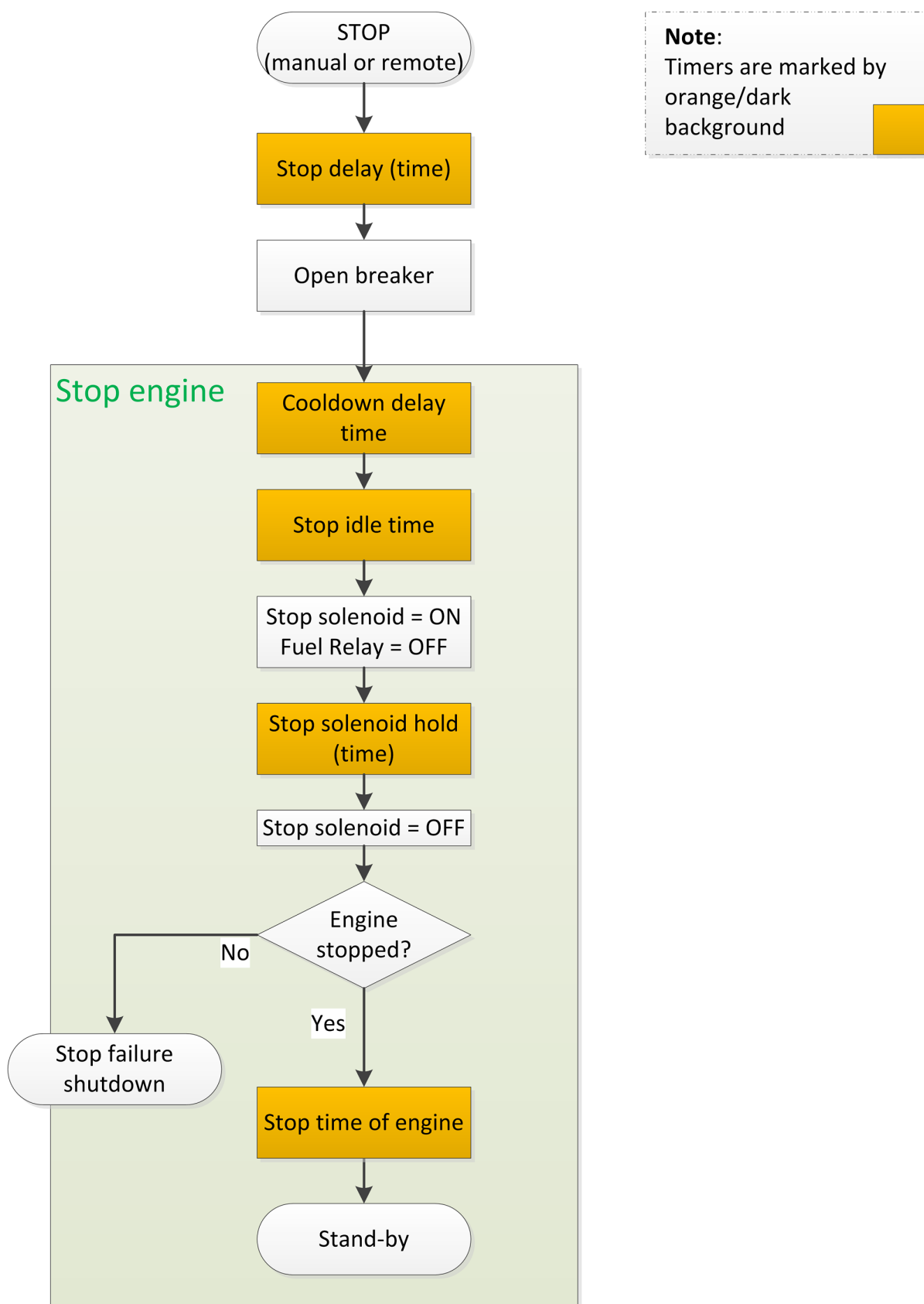



Fig. 18: Engine stop/stand-by procedure

### 5.4.3 MANual START/STOP



*Engine control is separated from breaker management. Breaker(s) must be manually opened/closed (supply should be in normal range).*

#### MANual Start

1. ➔ Press the MAN button 
  - ⇒ The LED next to the button will illuminate to confirm the operation
2. ➔ Press the START button  to start the genset as described above. In case of abnormal conditions, such as overheating, low oil pressure, over speed and abnormal voltage during generator running occur, the controller can protect genset by stopping quickly.

#### MANual Stop

- ➔ Pressing  can stop the running generator as described above.

## 5.5 Transition Procedures

### 5.5.1 Disconnect during cranking

There are three conditions under control to abort the starting of the engine:

- speed sensor
- generator frequency
- engine oil pressure

They can be used separately or in combinations.

We recommend selecting all three at the same time: engine oil pressure together with speed sensor, and generator frequency. This allows for an immediate separation of the starter motor from the engine. Additionally, crank disconnect can be checked exactly.

When set to speed sensor, ensure that the number of flywheel teeth is the same as setting.



**Sensor not used?** Make sure not to select a sensor that is not in use. Otherwise, an error message might occur.



*If the speed sensor ("Firing speed RPM") is not selected, the rotating speed displayed on the controller is calculated from generator frequency and the number of poles.*

*If the generator frequency ("Firing speed Hz") is not selected, the relative power quantity will neither be registered nor displayed (e.g. water pump application).*



**HMI only! In ToolKit-SC frequency, speed, and oil pressure can be enabled/disabled separately; HMI is using a table "Firing speed" instead:**

No.	Setting description
0	Gen frequency
1	Speed sensor
2	Speed sensor + Gen frequency
3	Oil pressure
4	Oil pressure + Gen frequency
5	Oil pressure + Speed sensor
6	Oil pressure + Speed sensor + Gen frequency

## 5.6 Trouble Shooting

Symptoms	Possible Solutions
Controller has no power.	Check starting batteries; Check controller connection wiring; Check DC fuse.
Genset shutdown	Check if the water/cylinder temperature exceeds the limits; Check the genset AC voltage; Check DC fuse.
Controller emergency stop	Check if emergency stop button works properly; Check whether the starting battery's positive pole is connected to the emergency stop input; Check whether the circuit is open.
Low oil pressure alarm after crank disconnect	Check the oil pressure sensor and its connections.
High water temp. alarm after crank disconnect	Check the temperature sensor and its connections.
Shutdown Alarm in running	Check the switch and its connections according to the information on LCD; Check auxiliary input ports.
Fail to start	Check the fuel oil circuit and its connections; Check the starting batteries; Check the speed sensor and its connections; Refer to the engine manual.
Starter no response	Check the starter connections; Check the starting batteries.
Genset running while ATS not transfer	Check the ATS; Check the connections between ATS and controllers.
ECU communication failed	Check the CAN connections for high and low polarity; Check if the 120 Ω resistor is connected properly; Check if the type of engine is correct; Check if the connections from the controller to the engine and the output ports settings are correct.
ECU warning or shutdown	Get information from the LCD of the alarm page; If there is a detailed alarm, check the respective engine. If there is no detailed alarm, please refer to the relevant section of the engine manual as specified in the SPN alarm code.

## Operation

---

Trouble Shooting

## 6 Application

### 6.1 Commissioning

Please go to the steps below, before starting normal operation

1. ➤ Ensure all the connections are correct and wires diameter is suitable
2. ➤ Ensure that the controller DC power has fuse, controller's positive and negative connected to start battery are correct
3. ➤ Emergence stop must be connected with positive of start battery via scram button's normal close point and fuse
4. ➤ Take proper action to prevent engine to crank disconnect (e. g. Remove the connection wire of fuel valve). If checking is OK, make the start battery power on; choose manual mode and controller will executive routine
5. ➤ Set controller under manual mode, press start button **I**, genset will start. After the setting times as setting, controller will send signal of Start Fail; then press stop button **STOP** to reset controller
6. ➤ Recover the action of stop engine start (e. g. connect wire of fuel valve), press **I** again, genset will start. If everything goes well, genset will normal run after idle running (if idle run be set). During this time, please watch for engine's running situations and AC generator's voltage and frequency. If abnormal, stop genset running and check all wires connection according to this manual
7. ➤ If there is any other question, please contact your local Woodward support

## Application

---

Commissioning

## 7 Interfaces and Protocols

### 7.1 J1939

#### Cummins ISB/ISBE

Terminals of controller	Connector B	Remark
Fuel relay output	39	
Start relay output	-	Connect with starter coil directly
Auxiliary output port 1	Expand 30A relay, battery voltage of 01, 07, 12, 13 is supplied by relay	ECU power Set Auxiliary output 1 as "ECU power"
Terminals of controller	9 pins connector	Remark
CAN GND	SAE J1939 shield	CAN communication shielding line(connect with ECU terminal only)
CAN(H)	SAE J1939 signal	Impedance 120 $\Omega$ connecting line is recommended.
CAN(L)	SAE J1939 return	Impedance 120 $\Omega$ connecting line is recommended.

#### Cummins QSL9 / CM850 engine control module

Terminals of controller	50 pins connector	Remark
Fuel relay output	39	
Start relay output	-	Connect to starter coil directly
Terminals of controller	9 pins connector	Remark
CAN GND	SAE J1939 shield-E	CAN communication shielding line(connect with ECU terminal only)
CAN(H)	SAE J1939 signal-C	Impedance 120 $\Omega$ connecting line is recommended.
CAN(L)	SAE J1939 return-D	Impedance 120 $\Omega$ connecting line is recommended.

#### Cummins QSM 11 (Import) / CM570 engine control module

Terminals of controller	C1 connector	Remark
Fuel relay output	5&8	Outside expand relay, when fuel output, making port 5 and port 8 of C1 be connected
Start relay output	-	Connect to starter coil directly
Terminals of controller	3 pins data link connector	Remark
CAN GND	C	CAN communication shielding line(connect with ECU terminal only)
CAN(H)	A	Impedance 120 $\Omega$ connecting line is recommended.
CAN(L)	B	Impedance 120 $\Omega$ connecting line is recommended.

#### Cummins QSX15-CM570

Terminals of controller	50 pins connector	Remark
Fuel relay output	38	Oil spout switch
Start relay output	-	Connect to starter coil directly
Terminals of controller	9 pins connector	Remark
CAN GND	SAE J1939 shield-E	CAN communication shielding line(connect with ECU terminal only)

## Interfaces and Protocols

J1939

Terminals of controller	50 pins connector	Remark
CAN(H)	SAE J1939 signal-C	Impedance 120 $\Omega$ connecting line is recommended.
CAN(L)	SAE J1939 return-D	Impedance 120 $\Omega$ connecting line is recommended.

### Cummins QSM11 / Common J1939

Terminals of controller	OEM connector of engine	Remark
Fuel relay output	38	
Start relay output	-	Connect with starter coil directly
CAN GND	-	CAN communication shielding line(connect with controller's this terminal only)
CAN(H)	46	Impedance 120 $\Omega$ connecting line is recommended.
CAN(L)	37	Impedance 120 $\Omega$ connecting line is recommended.

### Cummins QSZ13 / Common J1939

Terminals of controller	OEM connector of engine	Remark
Fuel relay output	45	
Start relay output	-	Connect to starter coil directly
Auxiliary output 1	16&41	Setting to idle speed control; normally close output. Making 16 connect to 41 during high-speed running of controller via external expansion relay.
Auxiliary output 2	19&41	Setting to pulse raise speed control; normally open output. Making 19 connect with 41 for 0.1s during high-speed warming of controller via external expansion relay.
CAN GND	-	CAN communication shielding line(connect with controller's this terminal only)
CAN(H)	1	Impedance 120 $\Omega$ connecting line is recommended.
CAN(L)	21	Impedance 120 $\Omega$ connecting line is recommended.

### Detroit Diesel DDEC III-IV / Common J1939

Terminals of controller	CAN port of engine	Remark
Fuel relay output	Expand 30A relay; battery voltage of ECU is supplied by relay.	
Start relay output	-	Connect to starter coil directly
CAN GND	-	CAN communication shielding line(connect with controller's terminal only)
CAN(H)	CAN(H)	Impedance 120 $\Omega$ connecting line is recommended.
CAN(L)	CAN(L)	Impedance 120 $\Omega$ connecting line is recommended.

### Deutz EMR2 / Volvo EDC4

Terminals of controller	F connector	Remark
Fuel relay output	Expand 30A relay; battery voltage of terminal 14 is supplied by relay. Fuse is 16A.	
Start relay output	-	Connect to starter coil directly
-	1	Connect to battery negative pole

Terminals of controller	F connector	Remark
CAN GND	-	CAN communication shielding line(connect with controller's terminal only)
CAN(H)	12	Impedance 120 $\Omega$ connecting line is recommended.
CAN(L)	13	Impedance 120 $\Omega$ connecting line is recommended.

### John Deere

Terminals of controller	21 pins connector	Remark
Fuel relay output	G, J	
Start relay output	D	
CAN GND	-	CAN communication shielding line(connect with controller's terminal only)
CAN(H)	V	Impedance 120 $\Omega$ connecting line is recommended.
CAN(L)	U	Impedance 120 $\Omega$ connecting line is recommended.

### MTU ADEC (Smart Module) / ECU8

Terminals of controller	ADEC (X1port)	Remark
Fuel relay output	X1 10	X1 Terminal 9 Connected to negative of battery
Start relay output	X1 34	X1 Terminal 33 Connected to negative of battery
Terminals of controller	SMART (X4 port)	Remark
CAN GND	X4 3	CAN communication shielding line(connect to controller's this terminal only)
CAN(H)	X4 1	Impedance 120 $\Omega$ connecting line is recommended.
CAN(L)	X4 2	Impedance 120 $\Omega$ connecting line is recommended.

### MTU ADEC (SAM Module) / ECU7, common J1939

Terminals of controller	ADEC (X1port)	Remark
Fuel relay output	X1 43	X1 Terminal 28 Connected to negative of battery
Start relay output	X1 37	X1 Terminal 22 Connected to negative of battery
Terminals of controller	SAM (X23 port)	Remark
CAN GND	X23 3	CAN communication shielding line(connect with controller's this terminal only)
CAN(H)	X23 2	Impedance 120 $\Omega$ connecting line is recommended.
CAN(L)	X23 1	Impedance 120 $\Omega$ connecting line is recommended.

### Perkins / ADEM3, ADEM4 with 2306, 2506, 2206, 1106, and 2806

Terminals of controller	Connector	Remark
Fuel relay output	110.153.334	
Start relay output	-	Connect to starter coil directly
CAN GND	-	CAN communication shielding line(connect with controller's terminal only)
CAN(H)	31	Impedance 120 $\Omega$ connecting line is recommended.
CAN(L)	32	Impedance 120 $\Omega$ connecting line is recommended.

## Interfaces and Protocols

J1939

### Scania / S6 with DC9, DC12, and DC16

Terminals of controller	B1 connector	Remark
Fuel relay output	3	
Start relay output	-	Connect to starter coil directly
CAN GND	-	CAN communication shielding line(connect with controller's terminal only)
CAN(H)	9	Impedance 120 $\Omega$ connecting line is recommended.
CAN(L)	10	Impedance 120 $\Omega$ connecting line is recommended.

### Volvo EDC3 / TAD1240, TAD1241, TAD1242



*When this engine type is selected, preheating time should be set to at least 3 seconds.*

Terminals of controller	"Stand alone" connector	Remark
Fuel relay output	H	
Start relay output	E	
Auxiliary output 1	P	ECU power Set Auxiliary output 1 as "ECU power"

Terminals of controller	"Data bus" connector	Remark
CAN GND	-	CAN communication shielding line(connect with controller's terminal only)
CAN(H)	1	Impedance 120 $\Omega$ connecting line is recommended.
CAN(L)	2	Impedance 120 $\Omega$ connecting line is recommended.

### Volvo EDC4 / TD520, TAD520 (optional), TD720, TAD720 (optional), TAD721, TAD722, and TAD732

Terminals of controller	Connector	Remark
Fuel relay output	Expand 30A relay; battery voltage of terminal 14 is supplied by relay. Fuse is 16A.	
Start relay output	-	Connect to starter coil directly
	1	Connected to negative of battery
CAN GND	-	CAN communication shielding line(connect with controller's terminal only)
CAN(H)	12	Impedance 120 $\Omega$ connecting line is recommended.
CAN(L)	13	Impedance 120 $\Omega$ connecting line is recommended.



**Volvo EMS2 / TAD734, TAD940, TAD941, TAD1640, TAD1641, and TAD1642.**



*When this engine type is selected, preheating time should be set to at least 3 seconds.*

Terminals of controller	Engine's CAN port	Remark
Auxiliary output 1	6	ECU stop Set Auxiliary output 1 as "ECU Stop"
Auxiliary output 2	5	ECU power Set Auxiliary output 2 as "ECU power"
	3	Negative power
	4	Positive power
CAN GND	-	CAN communication shielding line(connect with controller's terminal only)
CAN(H)	1(Hi)	Impedance 120 $\Omega$ connecting line is recommended.
CAN(L)	2(Lo)	Impedance 120 $\Omega$ connecting line is recommended.

**Yuchai / BOSCH**

Terminals of controller	Engine 42 pins port	Remark
Fuel relay output	1,40	Connect to engine ignition lock
Start relay output	-	Connect to starter coil directly
CAN GND	-	CAN communication shielding line(connect with controller's this terminal only)
CAN(H)	1,35	Impedance 120 $\Omega$ connecting line is recommended.
CAN(L)	1,34	Impedance 120 $\Omega$ connecting line is recommended.
Battery	Engine 2 pins	Remark
Battery negative	1	Wire diameter 2.5mm <sup>2</sup>
Battery positive	2	Wire diameter 2.5mm <sup>2</sup>

**Weichai / GTSC1 with BOSCH**

Terminals of controller	Engine port	Remark
Fuel relay output	1,40	Connect to engine ignition lock
Start relay output	1,61	
CAN GND	-	CAN communication shielding line(connect to the controller at this end only)
CAN(H)	1,35	Impedance 120 $\Omega$ connecting line is recommended.
CAN(L)	1,34	Impedance 120 $\Omega$ connecting line is recommended.

J1939

## 8 Technical Specifications

### Ambient

Items		Contents
Power Supply	Operating Voltage	8.0 V <sub>DC</sub> to 35.0 V <sub>DC</sub> , Continuous Power Supply. Reverse polarity protected
	Maximum supply voltage	Short Time 80 V (5-10 s) Long Time 50 V
	Minimum supply voltage	6.5 V
	Maximum operating current	(All relays closed, LCD bright) 380 mA (12 V); 188 mA (24 V)
	Maximum standby current	(All relays closed, LCD dimm) 90 mA (12 V); 42 mA (24 V)
Power Consumption		<3 W (standby ≤ 2 W)
Battery voltage measurement Accuracy		1% (12V/24V)
Alternator Input Range	3-Phase 4-Wire	AC15V-AC 360V (ph-N)
	3-Phase 3-Wire	AC30V - AC620V (ph-ph)
	Single-Phase 2-Wire	AC15V - AC360V (ph-N)
	2-Phase 3-Wire	AC15V - AC360V (ph-N)
AC-Measurement	Voltage Accuracy (400/480 V % rated)	Phase-phase: 100 .. 624 V : 1%; 50 .. 100 V : 1.5 % Phase-neutral: 100 .. 360 V : 1% 50 .. 100 V : 1.5 %
	Minimum frequency	Generator: 10 Hz
	Maximum frequency	Generator: 99.5 Hz
	Frequency resolution	0.1 Hz (10 .. 99 Hz)
	Frequency accuracy	±0.1 Hz
	Nominal CT secondary rating	5 A
	Overload Measurement	Max.: 10 A
	Current Accuracy	1 %
Alternator Frequency		50 Hz/60 Hz
Case Dimension		135 mm x 110 mm x 44 mm
Panel Cutout		116 mm x 90 mm
Working Conditions		Temperature: (-25 to +70) °C; Humidity: (20 to 93) %RH
Storage Condition		Temperature: (-25 to +70) °C
Protection Level against water and dust		Front: IP65 by using mounting material delivered with device Back: IP20

## Technical Specifications

Items	Contents
Insulating Intensity	Apply 2.2 kV <sub>AC</sub> voltage between high voltage terminal and low voltage terminal.  The leakage current is not more than 3 mA within 1 min.
Net Weight	0.xx kg

## Inputs/Outputs

Items	Contents	
Speed Sensor	Voltage	1.0 V to 24.0 V (RMS)
	Frequency	10,000 Hz (max.)
Excitation current D+	110 mA (12 V)	
	230 mA (24 V)	
Start Relay Output	16A DC28V supply output	
Fuel Relay Output	16A DC28V supply output	
	7A DC28V supply output	
	7A AC250V voltage free output	
Digital Inputs	Low level threshold	Approx. 1.3 V
	Maximum input voltage	60V
	Minimum input voltage	0 V
	High level threshold	1.7 V
CAN port (isolated)	Baud rate	250 K
USB Port	Max. allowed cable length	1.5 m

## Approvals

EMC test (CE)	Tested according to applicable EMC standards
Listings	CE marking
	UL6200/cUL
	NFPA110

## Display

- 132 x 64 monochrome LCD with backlight, multilingual interface (including English, Chinese or other languages) which can be chosen at the site, making commissioning convenient for factory personnel
- LCD wear-resistance and scratch resistance due to hard screen acrylic;

## Housing

- Silicon panel and pushbuttons for better operation in high-temperature environment;
- Waterproof security level IP55 due to rubber seal installed between the controller enclosure and panel fascia

- Metal fixing clips enable perfect in high temperature environment
- Modular design, self-extinguishing ABS plastic enclosure, pluggable connection terminals and embedded installation way; compact structure with easy mounting

#### Interfaces

- CANbus port and can communicate with J1939 genset:
  - Monitoring frequently-used data (such as water temperature, oil pressure, speed, fuel consumption and so on) of ECU
  - Control START, STOP, raising speed, and speed droop

#### Phase Configuration

- Suitable for 3-phase 4-wire, 3-phase 3-wire, single phase 2-wire, and 2-phase 3-wire systems with
  - voltage 120/240 V and
  - frequency 50/60 Hz

## 8.1 Measuring and Monitoring

- Measures and monitors
  - 3-phase voltage, current, power parameter, and frequency of generator.

#### Generator

- Line voltage (Uab, Ubc, and Uca)
- Phase voltage (Ua, Ub, and Uc)
- Phase sequence
- Frequency Hz
- For generator, controller has over and under voltage, over and under frequency, loss of phase, phase sequence wrong, over and reverse power, over current functions

#### Load

- Current IA, IB, IC
- Each phase and total active power kW
- Each phase and total reactive power kvar
- Each phase and total apparent power kVA
- Each phase and average power factor PF
- Accumulate total generator power kWh, kvarh, kVAh
- Earth current A

#### Miscellaneous

- 3 fixed analog sensors (temperature, oil pressure and fuel level)
- Precision measure and display parameters about Engine:
  - Temp. (WT) °C/°F both be displayed
  - Oil pressure (OP) kPa/psi/bar all be displayed
  - Speed (SPD) r/min (unit)
  - Battery Voltage (VB) V (unit)

## Technical Specifications

---

### Measuring and Monitoring

- Charger Voltage (VD) V (unit)
- Hour count (HC) can accumulate to max. 65535 hours.
- Start times can accumulate to max. 65535 times

## 9 Appendix

### 9.1 Alarms and Warnings

#### 9.1.1 Alarm Classes

Alarm class	Visible in the display	LED and horn	Open GCB	Shut-down engine	Engine blocked until acknowledge
Warn	X				
	This alarm does not interrupt the operation of the unit. An output of the centralized alarm occurs and the "Horn" command is issued. Alarm text + flashing LED + Relay centralized alarm (horn)				
Shutdown	X	X	Immediately	Immediately	X
	The GCB is opened and the engine is stopped. Alarm text + flashing LED + Relay centralized alarm (horn) + GCB open + Engine stop.				
Trip/shut	x	x	Immediately	Cool down time	X
	The GCB is opened immediately and the engine is stopped after cool down. Alarm text + flashing LED + Relay centralized alarm (horn) + GCB open + Cool down + Engine stop.				
Trip	X	X	X		
	The GCB is opened but does not interrupt the operation of the unit. Alarm text + flashing LED + Relay centralized alarm (horn) + GCB open.				
Indication	X				
	This alarm does not interrupt the operation of the unit. A message output without a centralized alarm occurs. Alarm text				

#### 9.1.2 Warnings

No.	Items	Description
1	Loss Of Speed Signal	When the speed of genset is 0 and speed loss delay is 0, controller will send a warning alarm signal that will be displayed in LCD.
2	Genset Over Current	When the current of genset is higher than threshold and setting over current delay is 0, controller will send warning alarm signal and it will be displayed in LCD.
3	Fail To Stop	When genset cannot stop after the "stop delay" is over, controller will send warning alarm signal and it will be displayed in LCD.
4	Low Fuel Level	When the fuel level of genset is lower than threshold or low fuel level warning is active, controller will send warning alarm signal and it will be displayed in LCD.
5	Failed To Charge	When the voltage of genset charger is lower than threshold, controller will send warning alarm signal and it will be displayed in LCD.
6	Battery Under Voltage	When the battery voltage of genset is lower than threshold, controller will send warning alarm signal and it will be displayed in LCD.
7	Battery Over Voltage	When the battery voltage of genset is higher than threshold, controller will send warning alarm signal and it will be displayed in LCD.
8	Low Coolant Level	When low coolant level input is active, controller will send warning alarm signal and it will be displayed in LCD.
9	Temp. Sensor Open	When sensor hasn't connected to corresponding port, controller will send warning alarm signal and it will be displayed in LCD.
10	Oil Pressure Sensor Open	When sensor hasn't connected to corresponding port, controller will send warning alarm signal and it will be displayed in LCD.
11	Maintenance Warn	When genset running time is longer than maintenance time of user setting, and the maintenance action is set as warning, controller send warning alarm signal and it will be displayed in LCD. When maintenance action type is set as "Not used", maintenance alarm reset.
12	High Temp.	When the water/cylinder temperature of genset is higher than threshold and Enabled High Temp. Stop Inhibited or Input High Temp. Stop Inhibited is active, controller will send warning alarm signal and it will be displayed in LCD.

## Appendix

### Alarms and Warnings > Shutdown Alarms

No.	Items	Description
13	Low Oil Pressure	When the oil pressure of genset is less than threshold and Enabled Low Oil Pressure Stop Inhibited or Input Low Oil Pressure Stop Inhibited is active, controller will send warning alarm signal and it will be displayed in LCD.
14	Input Warn	When external input is active, controller will send warning alarm signal and it will be displayed in LCD.
15	Failed To Charge	When Failed To Charge input is active, controller will send warning alarm signal and it will be displayed in LCD.
16	Over Power	If over power detection is enabled, when the controller detects that the over power value (power is positive) has exceeded the pre-set value and the action select "Warn", it will initiate a warning alarm.
17	ECU Warn	If an error message is received from ECU via J1939, it will initiate a warning alarm.

### 9.1.3 Shutdown Alarms

When controller detects shutdown alarm, it will send signal to open breaker and shuts down generator.

No.	Items	Description
2	High Temp. Shutdown	When the temperature of water/cylinder is higher than set threshold, controller will send a stop alarm signal and it will be displayed on the LCD.
3	Low Oil Pressure Shutdown	When oil pressure is lower than threshold, controller will send a stop alarm signal and it will be displayed on the LCD.
4	Over Speed Shutdown	When genset speed is higher than set threshold, controller will send a stop alarm signal and it will be displayed on the LCD.
5	Under Speed Shutdown	When genset speed is lower than set threshold, controller will send a stop alarm signal and it will be displayed on the LCD.
6	Loss Of Speed Signal Shutdown	When rotate speed is 0 and delay is not 0, controller will send a stop alarm signal and it will be displayed on the LCD.
7	Genset Over Voltage Shutdown	When genset voltage is higher than threshold, controller will send a stop alarm signal and it will be displayed on the LCD.
8	Genset Under Voltage Shutdown	When genset voltage is under set threshold, controller will send a stop alarm signal and it will be displayed on the LCD.
9	Genset Over Current Shutdown	When genset current is higher than set threshold and delay is not 0, it will send a stop alarm signal and it will be displayed on the LCD.
10	Failed To Start	Within set start times, if failed to start, controller will send a stop alarm signal and it will be displayed on the LCD.
11	Over Freq. Shutdown	When genset frequency is higher than set threshold, controller will send a stop alarm signal and it will be displayed on the LCD.
12	Under Freq. Shutdown	When genset frequency is lower than set threshold, controller will send a stop alarm signal and it will be displayed on the LCD.
13	Genset Failed	When genset frequency is 0, controller will send a stop alarm signal and it will be displayed on the LCD.
14	Low Fuel Level	When fuel level low input is active, controller will send a stop alarm signal and it will be displayed on the LCD.
15	Low Coolant Level	When genset coolant level low input is active, controller will send a stop alarm signal and it will be displayed on the LCD.
16	Temp. Sensor Open	When sensor hasn't connected to corresponding port, controller will send shutdown alarm signal and it will be displayed on the LCD.
17	Oil Sensor Open	When sensor hasn't connected to corresponding port, controller will send shutdown alarm signal and it will be displayed on the LCD.



No.	Items	Description
18	Maintenance shutdown	When the genset running time is longer than the maintenance time of the user setting and maintenance action is set to shutdown, the controller send a shutdown alarm signal and it will be displayed on the LCD. When the maintenance action type is set to "Not used", maintenance alarm resets.
19	Input Shutdown	When the external input is active, the controller will send a shutdown alarm signal and it will be displayed on the LCD.
20	Over Power	If the over power detection is enabled, the controller will initiate a shutdown alarm, when it detects that the over power value (power is positive) has exceeded the pre-set value and the selected action is "Shutdown".
21	ECU Shutdown	If an error message is received from ECU via J1939, it will initiate a shutdown alarm.
22	ECU Fail	If the module does not detect the ECU data, it will initiate a shutdown alarm.

## 9.2 Trouble Shooting

Symptoms	Possible Solutions
Controller has no power.	Check starting batteries; Check controller connection wiring; Check DC fuse.
Genset shutdown	Check if the water/cylinder temperature exceeds the limits; Check the genset AC voltage; Check DC fuse.
Controller emergency stop	Check if emergency stop button works properly; Check whether the starting battery's positive pole is connected to the emergency stop input; Check whether the circuit is open.
Low oil pressure alarm after crank disconnect	Check the oil pressure sensor and its connections.
High water temp. alarm after crank disconnect	Check the temperature sensor and its connections.
Shutdown Alarm in running	Check the switch and its connections according to the information on LCD; Check auxiliary input ports.
Fail to start	Check the fuel oil circuit and its connections; Check the starting batteries; Check the speed sensor and its connections; Refer to the engine manual.
Starter no response	Check the starter connections; Check the starting batteries.
Genset running while ATS not transfer	Check the ATS; Check the connections between ATS and controllers.
ECU communication failed	Check the CAN connections for high and low polarity; Check if the 120 $\Omega$ resistor is connected properly; Check if the type of engine is correct; Check if the connections from the controller to the engine and the output ports settings are correct.
ECU warning or shutdown	Get information from the LCD of the alarm page; If there is a detailed alarm, check the respective engine. If there is no detailed alarm, please refer to the relevant section of the engine manual as specified in the SPN alarm code.

## Appendix

---

Trouble Shooting

## 10 Glossary And List Of Abbreviations

<b>AM</b>	AnalogManager
<b>BDEW</b>	German community of 1,800 companies represented by the German Association of Energy and Water Industries (Bundesverband der Energie- und Wasserwirtschaft)
<b>CB</b>	Circuit Breaker
<b>CL</b>	Code Level
<b>CT</b>	Current Transformer
<b>DI</b>	Discrete Input
<b>DO</b>	Discrete (Relay) Output
<b>ECU</b>	Engine Control Unit
<b>FMI</b>	Failure Mode Indicator
<b>GAP</b>	Graphical Application Programming (GAP™)
<b>GCB</b>	Generator Circuit Breaker
<b>GCP</b>	Woodward device series (Genset Control) - not preferred for new design!
<b>GGB</b>	Generator Group Breaker
<b>GOV</b>	(speed) Governor; rpm regulator
<b>HMI</b>	Human Machine Interface e.g., a front panel with display and buttons for interaction
<b>I</b>	Current
<b>IOP</b>	Islanded Operation in Parallel ("Islanded Parallel Operation")
<b>LDSS</b>	Load-Dependent Start/Stop operation
<b>LM</b>	LogicsManager©
<b>LSG</b>	Woodward device: Load Share Gateway (communication converter)
<b>MCB</b>	Mains Circuit Breaker
<b>MFR</b>	Woodward device series (multifunctional relays) - not preferred for new design!
<b>MOP</b>	Mains Operation in Parallel
<b>MPU</b>	Magnetic Pickup Unit
<b>N.C.</b>	Normally Closed (break) contact
<b>N.O.</b>	Normally Open (make) contact
<b>NC</b>	Neutral Contactor
<b>OC</b>	Occurrence Count
<b>Operation</b>	In (general) operation.  State when the genset is running according to the selected mode, all parameters are in allowed values and ranges, and without OPEN requests or alarms. Somehow "waiting for next occurrence".
<b>P</b>	Real power
<b>P/N</b>	Part Number
<b>PF</b>	Power Factor
<b>PID</b>	Proportional Integral Derivative controller

## Glossary And List Of Abbreviations

---

<b>PLC</b>	Programmable Logic Control
<b>PT</b>	Potential (Voltage) Transformer
<b>Q</b>	Reactive power
<b>S</b>	Apparent power
<b>S/N</b>	Serial Number
<b>Sequencer</b>	A sequencer file is carrying specific settings e.g. to enable communication with and/or control of an expansion module. Such files can be prepared by Woodward.
<b>SPN</b>	Suspect Parameter Number
<b>V</b>	Voltage

---

## 11 Index

### C

Contact person ..... 11

Customer Service ..... 11

### I

Intended use ..... 11, 19

### M

Mounting ..... 21

### P

Personnel ..... 12

### S

Service ..... 11

Symbols

    in the instructions ..... 9

### U

Use ..... 11, 19

### W

Warranty ..... 11

Wiring ..... 21







Designed in Europe

**Woodward GmbH**

Handwerkstrasse 29

70565 Stuttgart

Germany

Phone +49 (0) 711 789 54-510

Fax +49 (0) 711 789 54-101

Stgt-Doku@woodward.com